



2N[®] Helios IP Vario

Door Access Intercom



Installation Manual

Version

1.0.3

www.2n.cz

The 2N TELEKOMUNIKACE a.s. joint-stock company is a Czech manufacturer and supplier of telecommunications equipment.



The product family developed by 2N TELEKOMUNIKACE a.s. includes GSM gateways, private branch exchanges (PBX), and door and lift communicators.

2N TELEKOMUNIKACE a.s. has been ranked among the Czech top companies for years and represented a symbol of stability and prosperity on the telecommunications market for almost two decades. At present, we export our products into over 120 countries worldwide and have exclusive distributors on all continents.



2N[®] is a registered trademark of 2N TELEKOMUNIKACE a.s.. Any product and/or other names mentioned herein are registered trademarks and/or trademarks or brands protected by law.



2N TELEKOMUNIKACE administers the FAQ database to help you quickly find information and to answer your questions about 2N products and services. On faq.2n.cz you can find information regarding products adjustment and instructions for optimum use and procedures „What to do if...“.



Declaration of Conformity

2N TELEKOMUNIKACE a.s. hereby declares that the 2N[®] Helios product complies with all basic requirements and other relevant provisions of the 1999/5/EC directive. For the full wording of the Declaration of Conformity see the CD-ROM enclosed and at www.2n.cz.



The 2N TELEKOMUNIKACE company is a holder of the ISO 9001:2008 certificate. All development, production and distribution processes of the company are managed by this standard and guarantee a high quality and advanced technical level of and a professional approach to all of our products.

Contents

1. Product Overview.....	5
1.1 Product Description	6
Basic Features.....	6
Advantages of Use	6
1.2 2N® Helios IP Vario Components and Associated Products	8
Basic Units.....	8
Extending Modules.....	9
Extenders	9
Mounting Accessories	10
VoIP Telephones.....	12
Electric Locks	12
Power Supply	12
Additional Modules	13
1.3 Terms and Symbols Used	14
Manual Symbols.....	14
2. Description and Installation.....	15
2.1 Before You Start	16
Product Completeness Check.....	16
2.2 Mounting – Mechanical Installation.....	17
Overview of Installation Types	17
Surface Mounting	18
Flush Mounting.....	22
Increased Resistance Version Installation	22
2.3 Mounting – Electrical Installation	23
Description of Printed Circuit Board Connectors.....	23
Configuration Connector Connection	29
Display Connector	29
Card Reader Connection.....	31
2.4 Mounting - Completion	32
Most Frequent Mounting Errors.....	32
2.5 Extending Module Connection.....	34
Maximum Count of Extenders.....	34
Module Cable Interconnection.....	35
Button Numbering	36
Button Numbering – Info Panel Sets.....	37

3.	Function and Use	39
3.1	Device Configuration	40
3.2	Intercomm Control as Viewed by External User	43
	Quick Dialling Buttons	43
	Calling to Telephone Directory Position	43
	Calling to User-Defined Telephone Number	43
	Incoming Call Answer and Reject	44
	Code Door Opening (Switch Activation)	44
	User Activation and Deactivation	44
	Profile Activation and Deactivation	44
3.3	Display-Equipped Intercom Viewed by External User	45
	Advertisement Mode	45
	Electronic Name Tags	45
	Calling to Number	46
	Telephone Directory	46
	Status Information	47
3.4	Intercom Control as Viewed by Internal User	48
	Receiving of 2N [®] Helios IP Vario Calls	48
	Calling to 2N [®] Helios IP Vario	48
	Code Door Opening (Switch Activation)	48
	User Activation and Deactivation	48
	Profile Activation and Deactivation	49
3.5	Maintenance	50
4.	Technical Parameters	51
4.1	Technical Parameters	52
5.	Supplementary Information	55
5.1	Regulations and Directives	56
5.2	General Instructions and Cautions	57
	Electric Waste and Used Battery Pack Handling	58
5.3	List of Figures	59
5.4	List of Tables	60

1

Product Overview

In this section, we introduce the **2N® Helios IP Vario** product, outline its application options and highlight the advantages following from its use.

Here is what you can find in this section:

- Product Description
- 2N® Helios IP Vario Components and Associated Products
- Changes
- Terms and Pictograms Used

1.1 Product Description

Basic Features

2N® Helios IP Vario is a highly reliable IP door access intercom provided with a lot of useful above-standard functions. Supporting the SIP standard and being compatible with the leading IP PBX and telephone suppliers, 2N® Helios IP Vario can make use of all VoIP services.

2N® Helios IP Vario can be equipped with a colour camera, which displays the calling person on the called party's video telephone or PC monitor.

2N® Helios IP Vario can be provided with up to 54 pre-programmed buttons. You can set up to three telephone numbers and time profiles for each of the buttons to increase the accessibility of the called party.

2N® Helios IP Vario can be equipped with a numerical keypad to be used as a code lock for lock switch activating or telephone/subscriber number dialling.

2N® Helios IP Vario is equipped with an electric lock switch. You can control the switch using a numerical keypad or, during a call, using any telephone set. An additional switch module can be installed if necessary. A wide range of settings allow for a variety of applications.

2N® Helios IP Vario can also be provided with RFID card reader modules.

2N® Helios IP Vario is very easy to install. All you have to do is connect the system into your LAN via a network cable and feed it from a 12V power supply or your PoE supporting LAN.

Configure **2N® Helios IP Vario** using your PC via any web browser. Use the **2N® Helios IP Manager** to manage extensive 2N® Helios IP Vario systems easily and quickly.

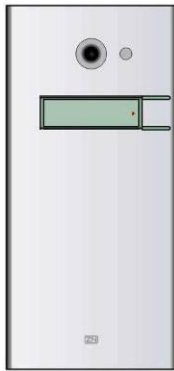
Advantages of Use

- Bidirectional communication – acoustic echo cancelling
- Integrated colour camera
- Optional dial buttons including name tags with backlight
- Optional numerical keypad with backlight
- Integrated electronic lock switches with wide setting options
- Optional integrated RFID card reader module
- LAN (PoE) or external 12V power supply
- Configuration via web interface or dedicated PC application
- SIP 2.0 support
- Up to 54 buttons pre-programmed buttons
- Up to 999 telephone directory positions

- Up to 20 user time profiles
- Video codecs (H.263+, H.264, MPEG-4, JPEG)
- Audio codecs (G.711, G.729)
- HTTP server for configuration
- SNTP client for time synchronisation with server
- RTSP server for video streaming
- SMTP client for e-mail sending
- TFTP client for automatic configuration and firmware update

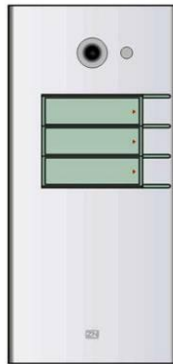
1.2 2N® Helios IP Vario Components and Associated Products

Basic Units



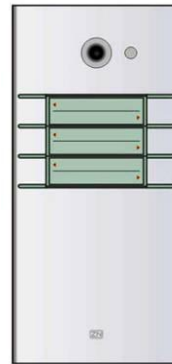
9137111(C)U

Basic unit
1 button



9137131(C)U

Basic unit
3 buttons



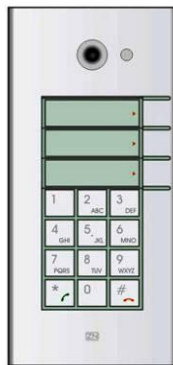
9137161(C)U

Basic unit
3×2 buttons



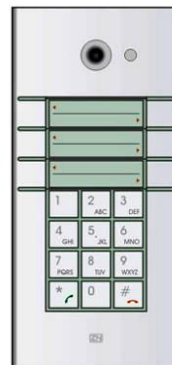
9137111(C)KU

Basic unit
1 button
+ keypad



9137131(C)KU

Basic unit
3 buttons
+ keypad



9137161(C)KU

Basic unit
3×2 buttons
+ keypad



9137160(C)KDU

Basic unit
3×2 buttons
+ keypad
+ display

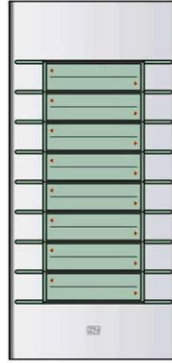
(C) = integrated camera

Extending Modules



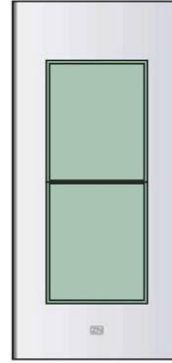
9135181E

Extending module
8 buttons



9135182E

Extending module
8×2 buttons



9135310E

Info panel

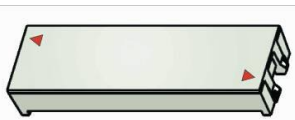
Backlit panel without buttons; used for insertion of a telephone directory, company logo, house number, etc.

Extenders



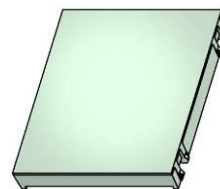
9135301E

Spare button name plate



9135302E

Spare double-button name plate



9135311E

Info panel – name plate

Replacing cover for four name tags. Helps you use a half of the extending module for insertion of a telephone directory, working hours, etc.



Tips

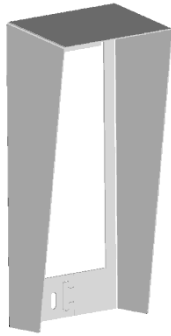
- All units can be surface mounted without needing any additional accessories.
- To make them even more robust and resistant, use a Vandal Resistant mask.



Caution

- For flush or outdoor mounting you need to use the accessories; see the Mounting Accessories subsection.

Mounting Accessories



9135331E

Surface 1-module roof

Dimensions

103×218×60 mm
(W×H×D)



9135351E

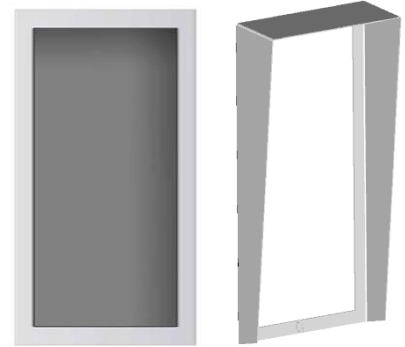
Wall mounting box
with 1-module frame

Dimensions

125×235×46 mm
(W×H×D)

Wall hole

110×220×50 ±5 mm



9135361E

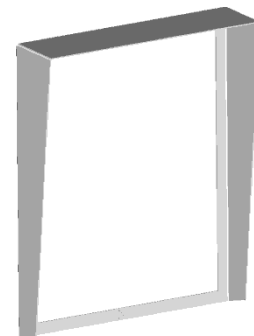
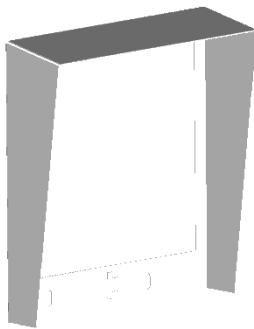
Wall mounting box
with 1-module roof

Roof dimensions

129×240×41 mm
(W×H×D)

Wall hole

110×220×50 ±5 mm



9135332E

Surface 2-module roof

Dimensions203×218×60 mm
(W×H×D)**9135352E**Wall mounting box
with 2-module frame**Dimensions**225×235×46 mm
(W×H×D)**Wall hole**

210×220×50 ±5mm

9135362EWall mounting box
with 2-module roof**Roof dimensions**229×240×41 mm
(W×H×D)**Wall hole**

210×220×50 ±5mm

The mounting accessories are made of stainless steel. For outdoor applications, the use of the roof is required unless weather protection is provided otherwise. The box with frame (without roof) allows for installation of 2N® Helios IP Vario in indoor applications so that the unit does not practically stick out (up to 1 mm).

VoIP Telephones



91378350

Grandstream GXV3140
VoIP video telephone



91378351

Grandstream GXV3175
VoIP video telephone

Electric Locks



932070E

BEFO 1211 12V / 600 mA



932080E

BEFO 1221
with momentum pin



932090E

BEFO 1211MB
with mechanical blocking

Power Supply



91378100E

91378100US

PoE injector



91341481E

Adapter 12 V/2 A

A stabilised power supply has to be used if the Ethernet (PoE) power supply is not available.



932928E

12 V transformer

Additional Modules



9137310E

Additional switch
Additional appliance control, normally open/closed contact option, time-unlimited connection, up to 48 V/2 A.



9137430E

Internal RFID card reader for 2N® Helios IP Vario mounting



9137420E

External RFID card reader for PC connection via USB interface



9159010

Security Relay



9159011

Wiegand Isolator



9137410E

External IP relay



9134165E

RFID card



9134166E

RFID key fob

1.3 Terms and Symbols Used

Manual Symbols



Safety

- **Always** abide by this information to prevent injury of persons.



Warning

- **Always** abide by this information to prevent damage to the device.



Caution

- **Important information** for system functionality.



Tip

- Useful advice.



Note

- Additional information.

2

Description and Installation

This section describes the **2N® Helios IP Vario** product and its installation.

Here is what you can find in this section:

- Product Description
- Before You Start
- Mounting – Mechanical Installation
- Mounting – Electrical Installation
- Connection of Extender Units

2.1 Before You Start

Product Completeness Check

Please check whether the contents of the package of your new 2N[®] Helios IP Vario complies with the following list.

- 1 2N[®] Helios IP Vario
- 1 installation CD
- 1 spare seal
- 1 drilling template
- 1 hexagonal wrench
- 1 spare name plate
- 1 terminal block plug
- 2 screws
- 2 dowels

2.2 Mounting – Mechanical Installation

Overview of Installation Types

An overview of the installation types and the list of the required components are provided in the table below.

Overview of installation types

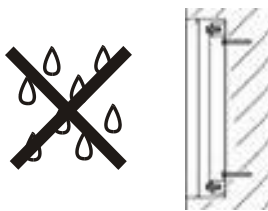
What you need for installation

Indoor, on surface



2N® Helios IP Vario only

Indoor, flush mounting

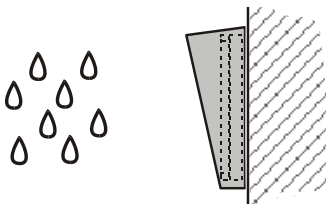


2N® Helios IP Vario

box with 1-module frame **9135351E**
or

box with 2-module frame **9135352E**

Outdoor, on surface



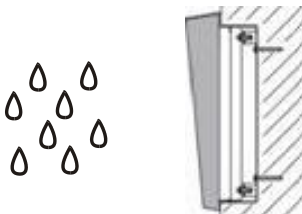
2N® Helios IP Vario

Surface 1-module roof **9135331E**

or

Surface 2-module roof **9135332E**

Outdoor, flush mounting



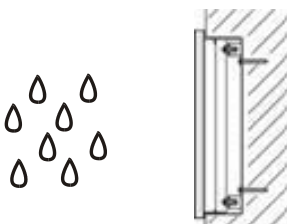
2N® Helios IP Vario

Wall mounting box with 1-module roof **9135361E**

or

Wall mounting box with 2-module roof **9135362E**

With increased resistance



2N® Helios IP Vario

Vandal resistant mask with box, version according to the assembly

Indoor application means:

Indoor areas with a low relative air humidity value (e.g., hallways, offices and other heated rooms).

Indoor areas where **humidity condenses** on walls **but never flows down the walls** (porches, storage areas, industrial areas, e.g.).

Outdoor areas where **protection against rain and water flowing down the wall is provided** (sheds, passages, e.g.).

Outdoor application means:

Environments where the product is exposed to rain or where water may flow down the walls (fence, outer wall of a building, e.g.).

**Caution**

- The warranty shall not apply to product failures and defects caused by improper installation (contrary to these instructions). The manufacturer is neither liable for damages caused by theft within an area that is accessible after the attached electric lock is switched. The product is not designed as a burglar protection device except when used in combination with a standard lock, which has the security function.

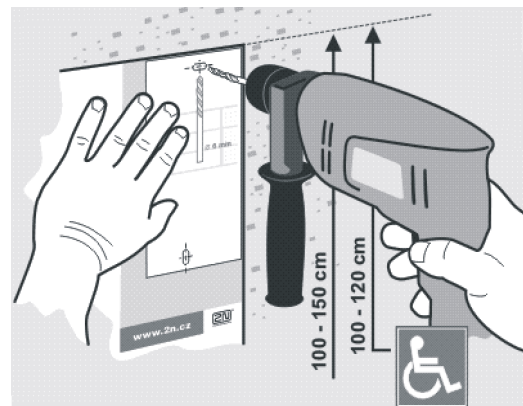
Surface Mounting

Figure 2.1 Hole Drilling

1. Drill holes according to the template included in the 2N[®] Helios IP Vario supply. Insert the included dowels in the wall holes.
2. Use the hexagonal wrench included in the supply and remove the 2N[®] Helios IP Vario metal cover. Remove the screw in the lower part of the metal cover and fold out the cover as shown in Figure 2.2.
3. Use a cross-head screwdriver to remove the plastic cover and demount the cover.

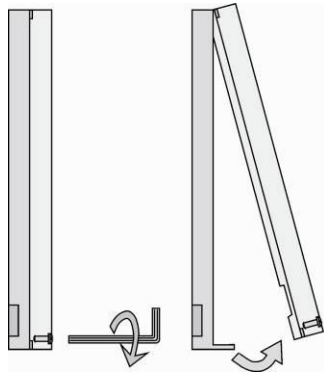


Figure 2.2 Cover Removing

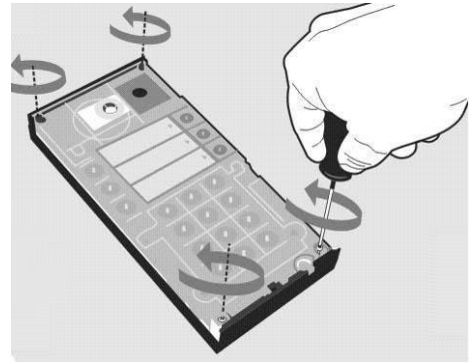


Figure 2.3 Plastic Cover Removing

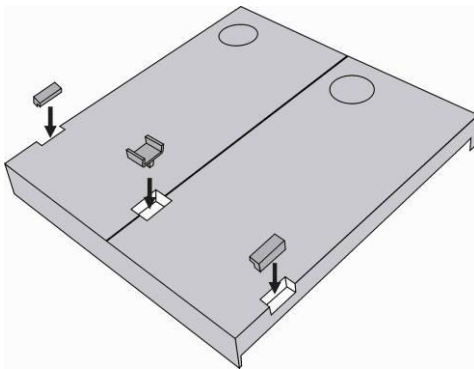


Figure 2.4 Multiple-Module Assembly



Warning

- Never remove the main board or camera electronics from under the lower cover while installing 2N® Helios IP Vario. Do not disconnect the camera flat cable from the main board. Do not bend and press upon the flat cable either.
4. In multiple-module assemblies connect the boxes according to Figure 2.4, placing the basic module to the left and the extending modules to the right. The interconnecting cable shall be connected later!
 5. Install blank modules on the unused side holes as shown in Figure 2.4.
 6. If you are installing a roof module, put it on the wall now.
 7. Fix 2N® Helios IP Vario on the wall with screws as shown in Figure 2.6. Carry the supply cables (Ethernet, lock, power cables) to the basic module box through one of the holes.



Warning

- Make sure that the mounting surface for the 2N® Helios IP Vario door communicator is perfectly flat. Avoid mechanical overload upon the bottom part of the cover. An incorrect installation on an uneven surface may lead to cover deformation and thus product malfunctions.

8. While installing a roof module, paste its top and side edges to the wall using silicon glue as shown in Figure 2.5 to prevent water from flowing into the box along or around the cables.
9. Connect the cables as described in subsection 2.4, Mounting – Electrical Installation. Make sure that the cables are not squeezed while installing the plastic cover. For the correct cable installation, refer to Figure 2.7.

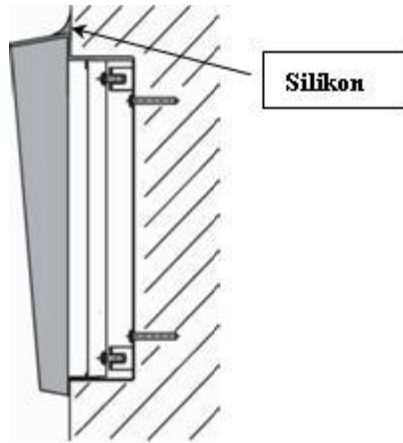


Figure 2.5 Roof Mounting

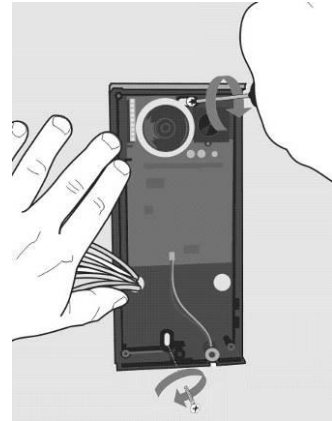


Figure 2.6 Wall Mounting

10. Remove the protective foil from the display (for display-equipped 2N® Helios IP Vario versions only).
11. Make sure that the cables are placed properly inside and that none of them obstructs a perfect cover closure.
12. Make sure that the three loudspeaker holder feet fit into the board holes. Keep the required loudspeaker position to make the seal work properly.
13. Having mounted the unit on the wall and connected all cables, replace the plastic cover using cross-recessed screws.



Warning

- Remember to tighten all the four corner screws to fix the loudspeaker seal after electric installation to avoid water in-leak! A PH2 cross-head screwdriver is recommended.

14. Take out the name plates from the plastic cover as shown in Figure 2.8. Use a flat-bladed screwdriver, for example.
15. Remove the inserts from the name plates.
16. Insert the printed foil labels.
17. Put the inserts back in the name plates.
18. Replace the name plates, clicking them into position. The name plates hold the matt foil inserted underneath.
19. Check whether a silicon seal is inserted in the top groove of the plastic cover. A spare seal package is included.
20. Close the metal cover and fix it with screws.

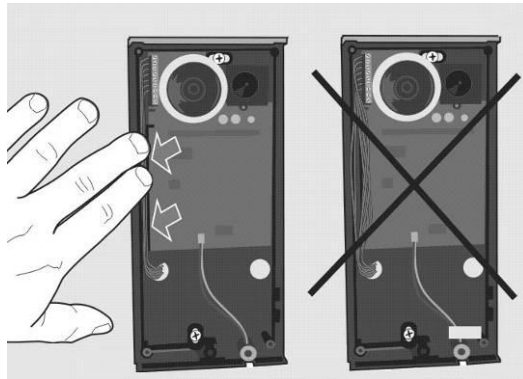


Figure 2.7 Cabling

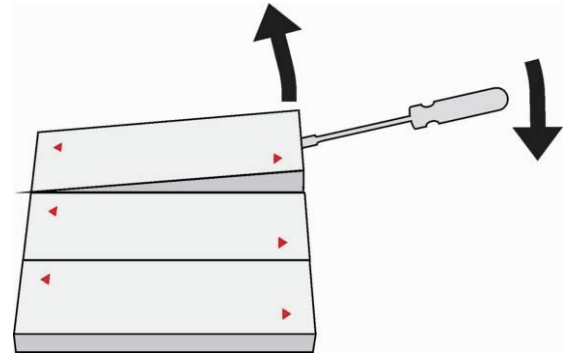


Figure 2.8 Name Plate Removing

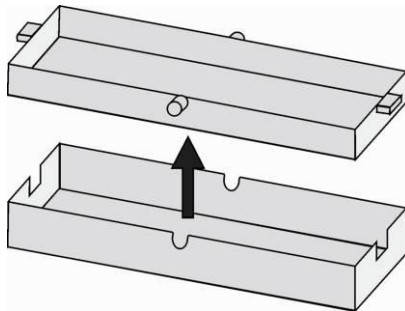


Figure 2.9 Insert Removing

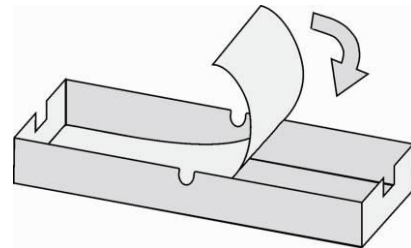


Figure 2.10 Label Inserting

Outdoor installation rules

- Always connect button backlighting – it is used for heating.
- The joint between the roof module and the wall must be filled with a waterproof cement to prevent water in-leak (see Figure 2.5).
- Water must not leak in along or around the cables.

Name tag material and printing

Each 2N® Helios IP Vario package includes a sheet of transparent foil for laser printing. Cut the printed foil into pieces and insert the labels in the name plates. Do not use paper to avoid water in-leak and paper damage.

Red arrows are printed on the name plate. Make sure that the text and the arrow do not overlap. We recommend you to use a template (MS Word) available at www.2n.cz for printing.

Single button
(whole)

Name 01
Name 02
Name 03

Double button
(horizontally divided)

Name 01
Name 04
Name 02
Name 05
Name 03

	Name 06
--	---------

Flush Mounting

Follow the installation instructions included in the flush mounting box delivery.

Increased Resistance Version Installation

Follow the installation instructions included in the AntiVandal box delivery.

2.3 Mounting – Electrical Installation

2N[®] Helios IP Vario is designed for connection in the Ethernet computer network (10/100BASE-T) using a UTP cable. Use a CAT 5e UTP cable at least for connection.

2N[®] Helios IP Vario is fed through the PoE (Power over Ethernet) technology. No additional cabling is therefore necessary. If your Ethernet is not equipped with the PoE technology, it is possible to use a PoE injector, Part No. 91378100. As an alternative, you can use a power adapter, Part No. 91341481E. 2N[®] Helios IP Vario is configured over an integrated administration web server, which can be controlled from any web browser, e.g., Mozilla Firefox.

Description of Printed Circuit Board Connectors

In **Figure 2.11** you can see the location of the printed circuit board (PCB) connectors. Connectors to which the accessories can be connected and connectors that serve for configuring 2N[®] Helios IP Vario are indicated on the board. The UTP cable for the Ethernet connection is to be connected to the terminal block X2 as shown in **Table 2.1**. The terminal block can be removed from the PCB. The connection of each of the connectors is described in the subsections below.

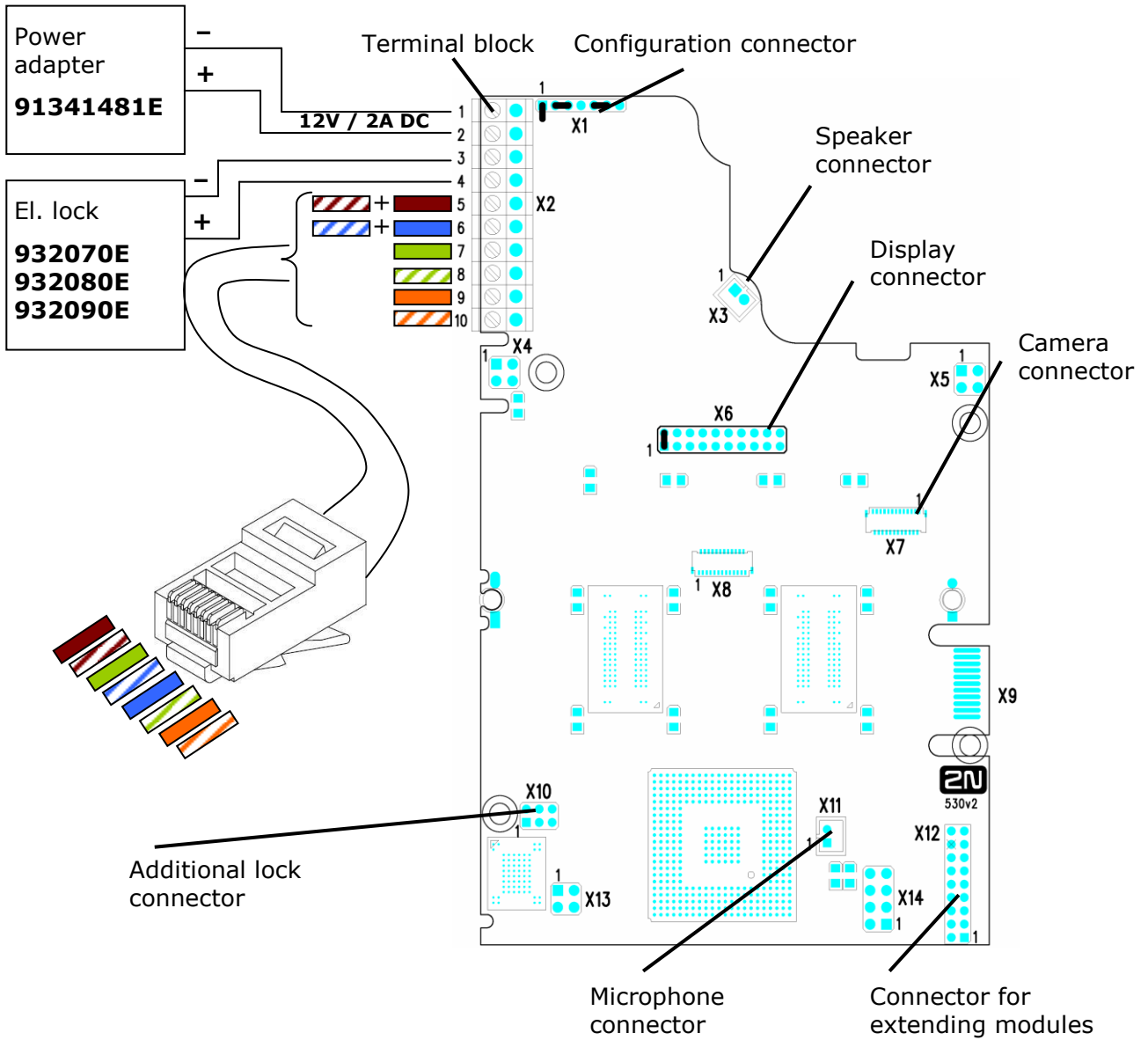


Figure 2.11 Description of 2N® Helios IP Vario Connectors, PCB Version 530v2

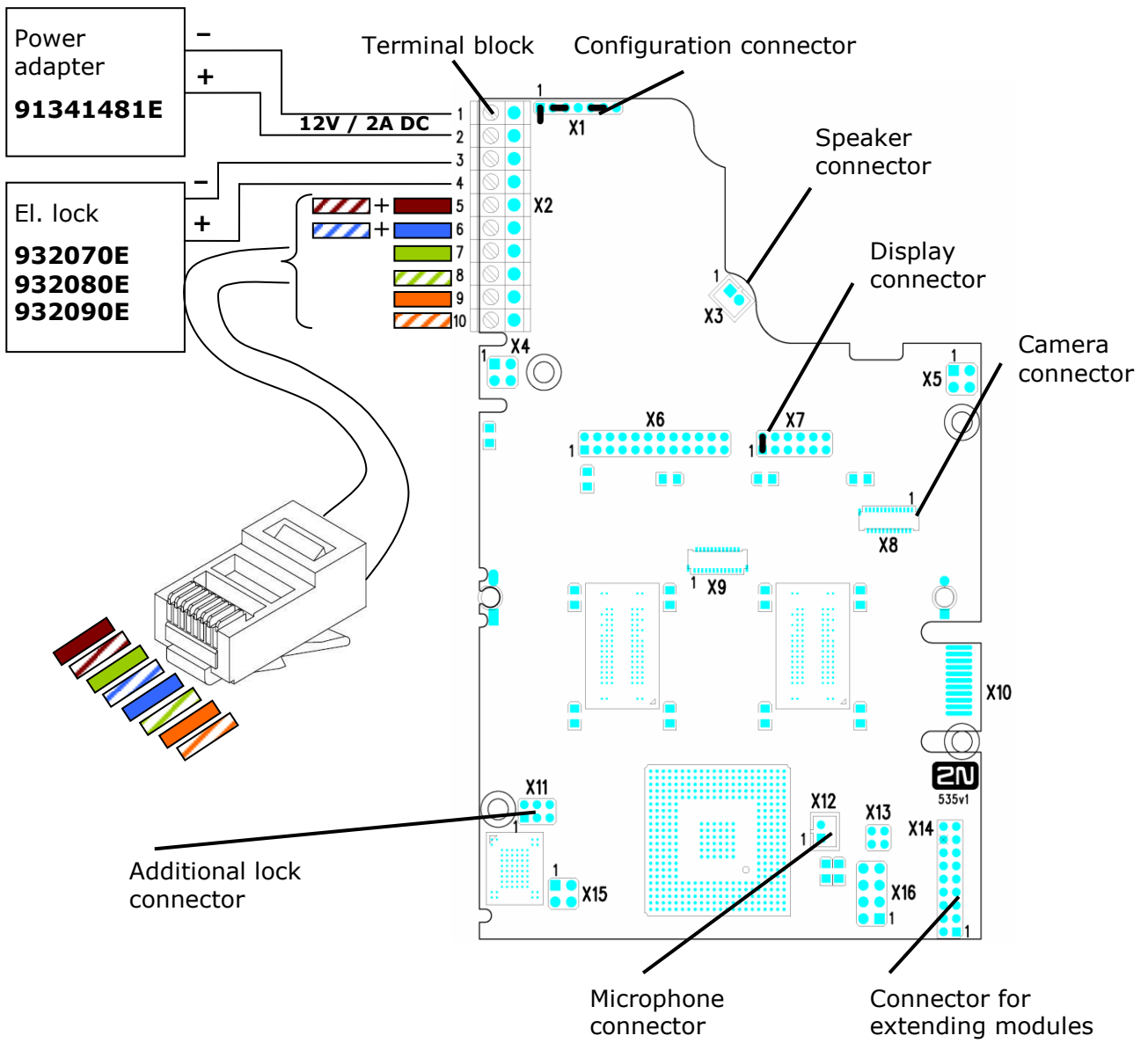


Figure 2.12 Description of 2N® Helios IP Vario Connectors, PCB Versions 535v1, 535v2

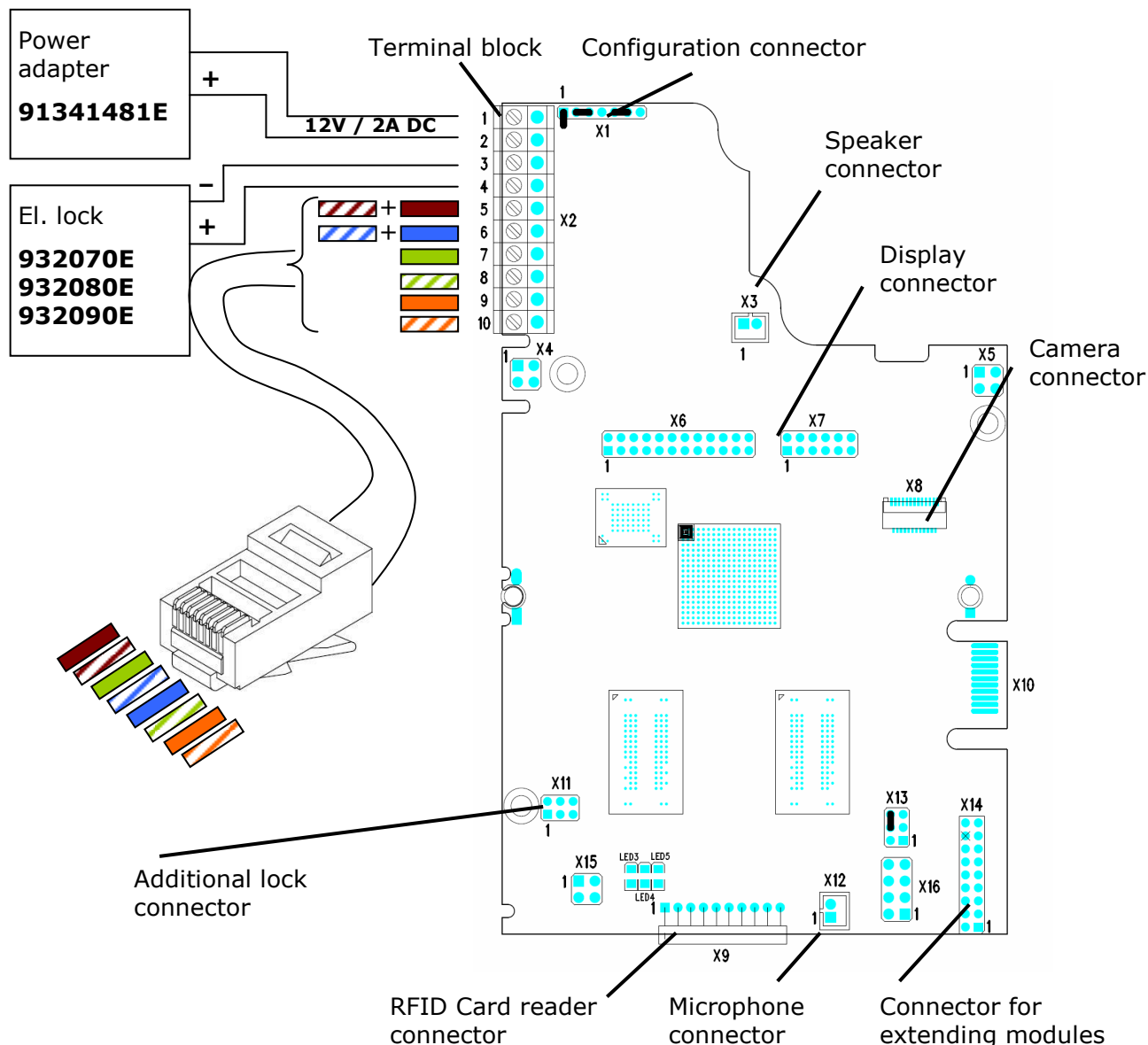


Figure 2.13 Description of 2N® Helios Vario IP Connectors, PCB Version 535v5

Terminal Block X2 Connection

Terminal block X2 includes 10 terminals whose functions are distinguished by colour. Terminals 5–10 are used for connecting 2N® Helios IP Vario to the Ethernet. Terminals 3–4 are designed for connecting the electric lock and terminals 1–2 help connect an external 12V / 2A DC power supply if no PoE power supply is available.

1. The terminal block is included in the package. To adjust an already installed 2N® Helios IP Vario, disconnect it IP from the power supply. Then pull to remove the terminal block from the printed circuit board.
2. Insert the wires under the respective terminals.
3. Tighten the terminals using a flat screwdriver.
4. Replace the terminal block to the printed circuit board.



Caution

- Make sure that the cables leading through the 2N® Helios IP Vario cover bottom groove are installed properly. For the correct installation of the cables refer to Figure 2.7.

Ethernet Connection

For the connections and meanings of the wires see the table below. Join UTP cable wires 4 (blue) and 5 (white-blue) and attach them under terminal 6 on 2N® Helios IP Vario. In the same way, join wires 7 and 8 and place them under terminal 5 of 2N® Helios IP Vario.

RJ-45		2N® Helios IP Vario			
	Pin No.	Marking	Colour	Terminal No.	
	1	Tx+		10	
	2	Tx -		9	
	3	Rx+		8	
	4	PoE -		6	
	5	PoE -		6	
	6	Rx -		7	
	7	PoE +		5	
	8	PoE +		5	

Table 2.1 Terminal Block Connections

Electric Lock Connection

The electric lock can be connected to terminals 3 and 4 of terminal block X2.

Electric lock	2N® Helios IP Vario			
	Marking	Colour	Terminal No	
<p>932070E 932080E 932090E</p>	-		3	
	+		4	

Table 2.2 Terminal Block Connection for Electric Lock

Terminals 3 and 4 are connected to a relay on the 2N® Helios IP Vario board. The relay terminals may act as normally open or normally closed contacts. Configuration is performed through the configuration connector X1 as described in the




Configuration Connector Connection subsection. Set on the configuration connector whether the electric lock will be powered from an external or internal power supply.

External Power Supply Connection

If the Ethernet network is not equipped with the PoE technology, you have two alternative options how to supply power to 2N® Helios IP Vario.

1. Using a PoE injector, Part No. 91378100. 2N® Helios IP Vario is then powered through an Ethernet cable as shown in Tab. 1 above.
2. Using a power adapter, Part No. 91341481E.

The external power supply from a power adapter can be connected to terminals 1 and 2.

Electric lock	2N® Helios IP Vario		
	Marking	Marking	Terminal No.
 <p>91341481E</p>	-		1
	+		2




Table 2.3 Terminal Block Connection for Power Adapter

Configuration Connector Connection

The configuration connector is located in the upper part of the printed circuit board. Use the configuration jumpers to set whether the lock control relay should have a normally open or normally closed function and whether it should be powered internally or externally.

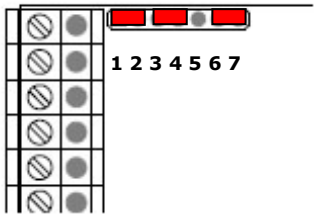
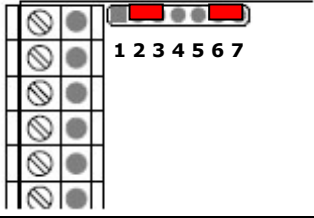
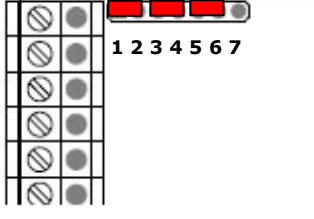
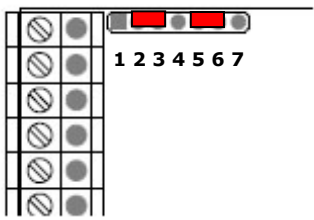
Lock power supply		Relay		Configuration connector
Internal	External	Normally closed	Normally open	Connection of jumpers
✓		✓		
	✓	✓		
✓			✓	
	✓		✓	

Table 2.4 Connection of Configuration Connector Jumpers

Display Connector

The display connector includes the name plate backlighting ON/OFF switching pins and 2N® Helios IP Vario resetting pins. The remaining pins are intended for display connection.

2N[®] Helios IP Vario resetting procedure

1. Switch 2N[®] Helios IP Vario off.
2. Connect the jumper into the resetting (default setting) position (put the display switch into the F_RES position in the display-equipped models with 535v1 and 535v2 board versions).
3. Switch 2N[®] Helios IP Vario on and wait for the acoustic start signalling.
4. Switch 2N[®] Helios IP Vario off.
5. Remove the jumper from the resetting (default setting) position (put the display switch into the NORMAL position in the display-equipped models with 535v1 and 535v2 board versions).
6. Switch 2N[®] Helios IP Vario on.


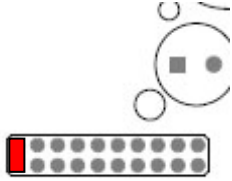
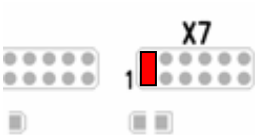
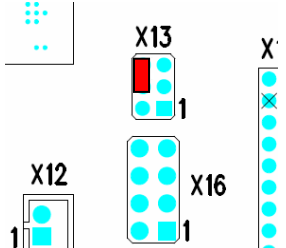

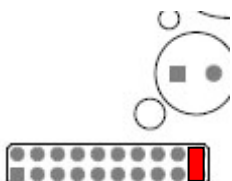
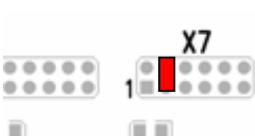
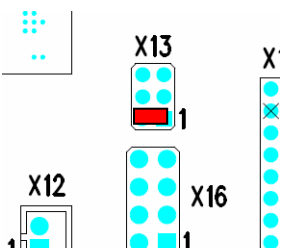
Normal operation	Default settings	Display connector X6 PCB version 530v2	Display connector X7 PCB version 535v1, 535v2	Connector X13 PCB version 535v5
				
				

Table 2.5 Configuration Jumpers on Display Connector

To reset the default values of a display-equipped 2N[®] Helios IP Vario, put the switch in the display right-hand bottom corner in position F_RES. This applies to modules with board versions 535v1 and 535v2 only. For 535v5 versions, use a jumper at connector X19.

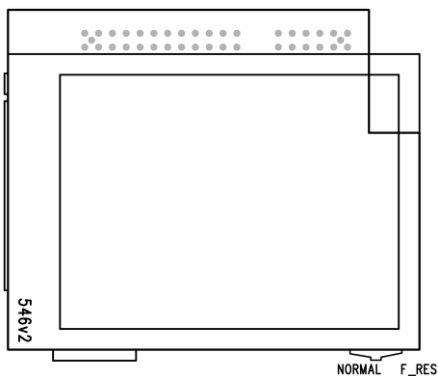


Figure 2.14 Resetting Procedure – Display Model

Card Reader Connection

2N[®] Helios IP Vario (Part Nos. 91371...U) can be equipped with an internal multifunction module including an RFID card reader (Part No. 9137430E). This module enhances the 2N[®] Helios IP Vario functions with an EM41XX RFID card reader, two relays for external load switching, two logical inputs and RS-485 and Wiegand interfaces. The current 2N[®] Helios IP Vario software version, however, supports the card reader and relays only.



Caution

- The 2N[®] Helios IP Vario modules ending with U (i.e. 91371...U) can only be equipped with the card reader.

Card Reader Mounting

1. Power off 2N[®] Helios IP Vario.
2. Use a hexagonal wrench to unscrew and remove the metal cover.
3. Use a cross-head screwdriver to unscrew and remove the plastic cover.
4. Connect the reader module into the 2N[®] Helios IP Vario basic unit bottom connector making sure that the microphone cable lies under the module.
5. Use the enclosed screws to fix the reader module to the 2N[®] Helios IP Vario plastic base.
6. Connect the wires for the reader module interface(s) if necessary.
7. Replace and fix the plastic cover using cross-head screws.
8. Replace and screw back the metal cover.



2.4 Mounting - Completion

1. Remember to seal the 2N[®] Helios IP Vario cable passage hole properly to avoid moisture in-leak and damage to electronics due to condensation.
2. Make sure that the wires inside 2N[®] Helios IP Vario are not squeezed and insert the plastic top cover (a transparent plastic mould) carefully making its contacts plug into the electronics board connectors. Push the plastic cover into position moderately. If the part swings over an obstacle or one corner is higher than the others, remove the cover and find the obstacle. Then tighten the corner screws properly.
3. Mounting the metal sheet cover follow the steps included in the subsection dedicated to name plate removal. Make sure that the cover fits well and is perfectly flat. If its bottom part is loose, the mounting wall is probably uneven. Support the corners to avoid 2N[®] Helios IP Vario bending.

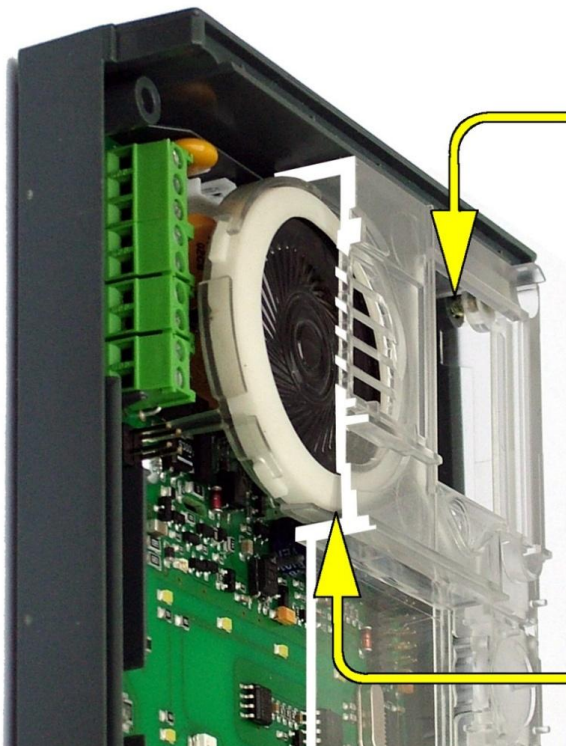


Caution

- *An improper mounting may significantly deteriorate the button function.*
- A poor outdoor mounting may cause water in-leak and damage to the electronics.

Most Frequent Mounting Errors

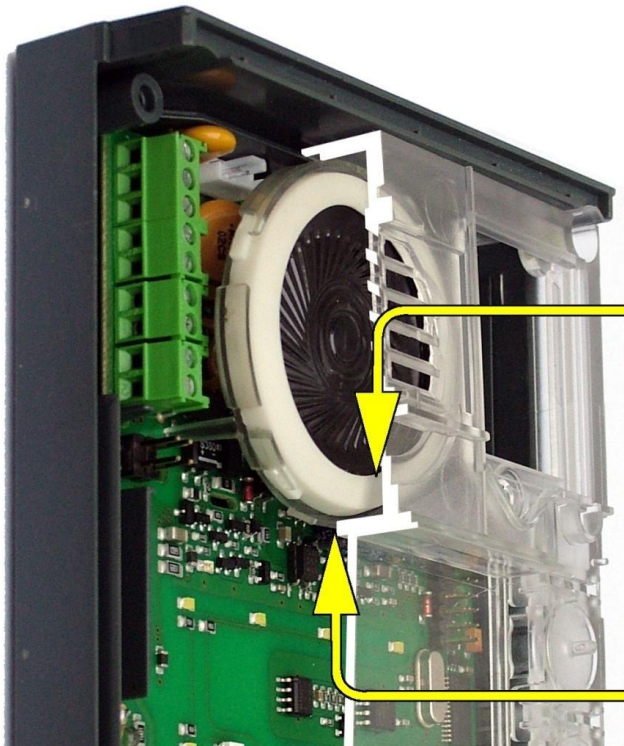
For illustration, a part of the plastic cover is removed in the figures below to reveal the sealed loudspeaker and the cover–seal touch point. The cross section plane is marked white for better orientation.



Poorly tightened screw
(a squeezed wire has the same effect)

WRONG

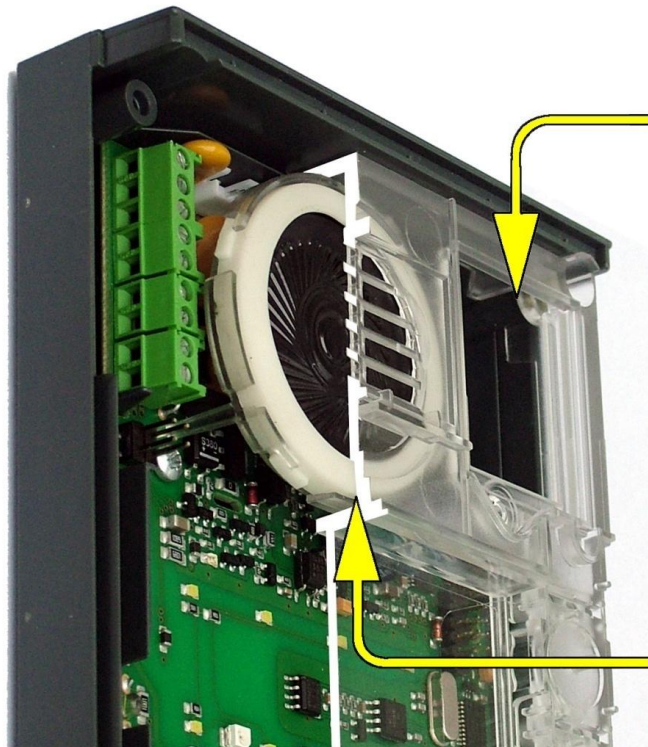
Gap between plastic cover and
loudspeaker seal
- water may leak in and
damage electronics



WRONG

Gap between plastic cover and loudspeaker seal
 - water may leak in and damage electronics

If the loudspeaker support is in a wrong position, the plastic cover may catch the support brim (see the arrow) and, if treated roughly, lead to component deformations. Leakage may arise, see the upper arrow.



Properly tightened screw

RIGHT

The seal touches the plastic cover. Water flows out through a small hole (not shown in the figure).

Note: Water does not affect the loudspeaker Mylar membrane.

2.5 Extending Module Connection

2N® Helios IP Vario features an easy installation of extending button modules. Extending modules are connected using a single cable (included in every extender delivery) in a chain pattern (every additional unit is connected with the previous one). Each extending module has two connectors – an input connector (for connection towards the 2N® Helios IP Vario basic unit) and an output connector (for connection of another, more remote unit). Be sure to maintain the correct orientation of the units and avoid connector mismatch to ensure a proper function of the device!

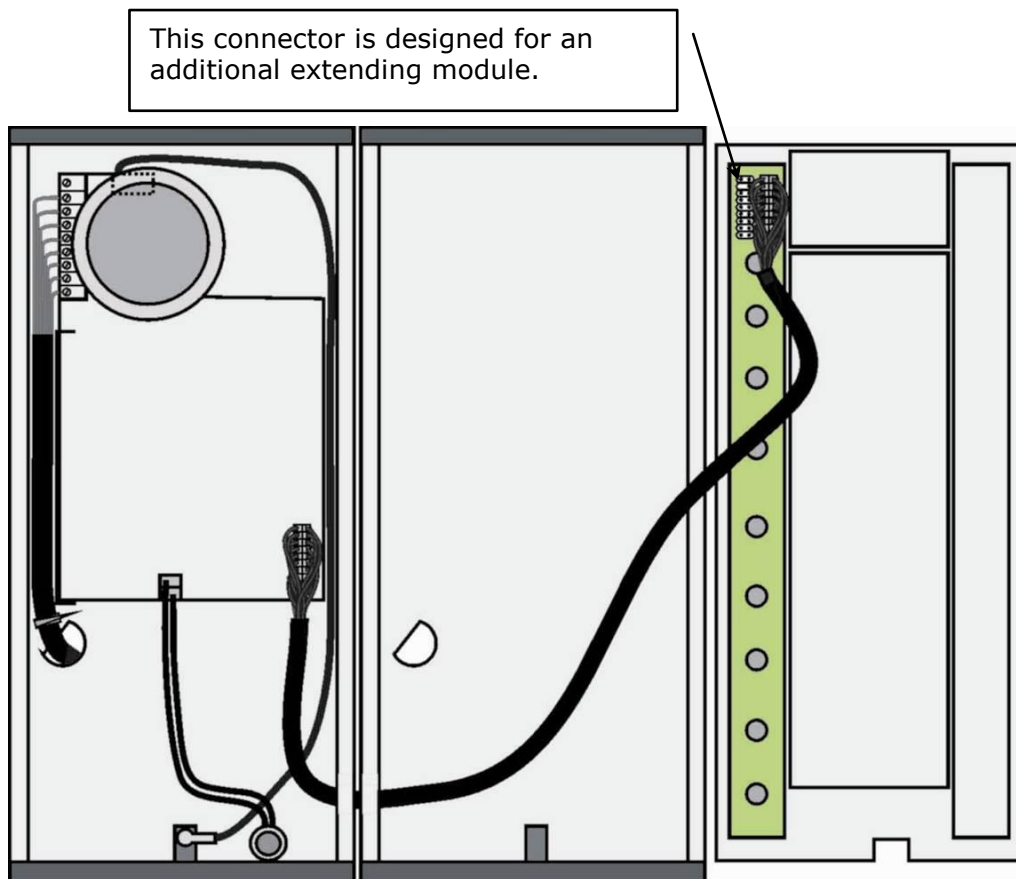


Figure 2.15 Connection of One-Row-Button Extending Modules

Maximum Count of Extenders

9135181E (1×8 buttons)	6	5	4	3	2	1	0
9135182E (2×8 buttons)	0	0	1	1	2	2	3

Table 2.6 Optional 2N® Helios IP Vario Extension

The table above shows how to combine modules with single (whole) and double buttons.

Module Cable Interconnection

- The cable is included in every extending module delivery. Both its ends are the same. Configuration is 1:1. Connectors cannot be shifted or inserted conversely because they are equipped with a so-called key.
- The basic unit is always on the left. Extenders are chain-connected, i.e. each is linked with its neighbour.
- The cable cannot be driven through the box interconnecting holes until the boxes have been connected (see subsection 2.3 Mounting – Mechanical Installation).

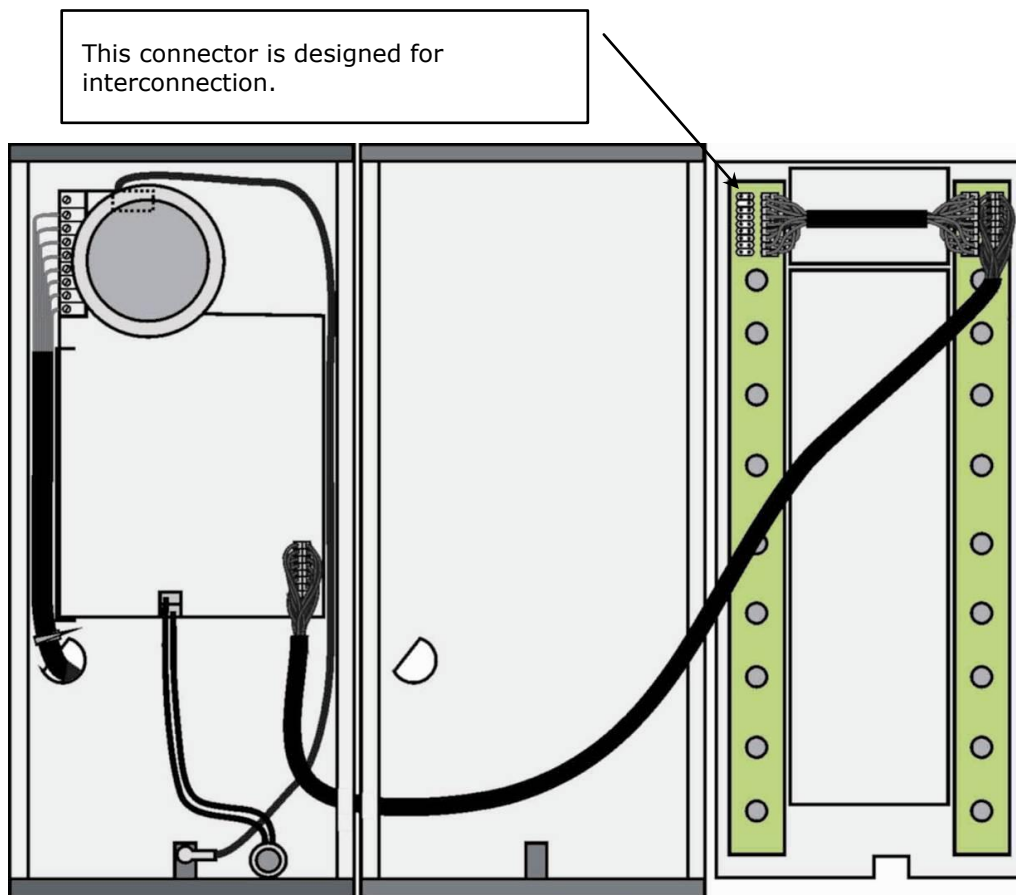


Figure 2.16 Connection of Two-Button-Row Extending Module



Caution

- The extending modules must be connected mutually and with the basic unit by means of a formed piece supplied with the extending module!!!

Button Numbering

Button numbering – one-button 2N[®] Helios IP Vario with a whole-button set

Also applies to keypad sets				
		7	15	23
		8	16	24
		9	17	25
		10	18	26
		11	19	27
		12	20	28
		13	21	29
		14	22	30
	1			

It is possible to continue to 54

Button numbering – whole-button sets

Also applies to keypad sets				
		7	15	23
		8	16	24
		9	17	25
		10	18	26
		11	19	27
		12	20	28
		13	21	29
		14	22	30
	1			
	2			
	3			

It is possible to continue to 54

Button numbering – double-button set

			7		15	23		31	39		47
1		4	8		16	24		32	40		48
2		5	9		17	25		33	41		49
3		6	10		18	26		34	42		50
Also applies to keypad sets			11		19	27		35	43		51
			12		20	28		36	44		52
			13		21	29		37	45		53
			14		22	30		38	46		54



Caution

- For the time being, AntiVandal panels are available only for single-button sets with one extending module at most.

Button Numbering – Info Panel Sets

Installing the info panel name plate, Part No. 9135311E, into any of the extending modules will not change the numbering system (the buttons on the info panel sides will remain functional). Connecting the info panel module, Part No. 9135310E, will result in omission of eight numbers.

4

Function and Use

This section describes the basic and extending functions of the product.

Here is what you can find in the section:

- Device configuration
- 2N[®] Helios IP Vario control
- Maintenance

3.1 Device Configuration

Use a PC equipped with any web browser to configure **2N® Helios IP Vario**:



- Launch your web browser (Internet Explorer, Firefox, etc.).
- Enter the IP address of your intercom (<http://192.168.1.100/>, e.g.).
- Log in using the **Admin** user name and **2n** password.

You have to know the IP address of your device to log in to the integrated web server. By default, 2N® Helios IP Vario is switched into the dynamic IP address mode, i.e. it obtains the IP address automatically if a properly set DHCP server is available in your LAN. If no such DHCP server is available, you can operate 2N® Helios IP Vario in the static IP address mode. Refer to the **2N® Helios IP Configuration Manual** for configuration details.

If your device remains inaccessible (you have forgotten the IP address, or the LAN configuration has changed, for example), change the LAN settings using the buttons on the device.

Static IP Address Setting

Follow the instructions below to enable the static IP address mode:

- Connect 2N® Helios IP Vario to the power supply (or, disconnect and reconnect it if already connected).
- Wait for the first acoustic signal .
- Press following buttons sequentially:
 - 1, 1, 1, 2, 2, 3 for 3-buttons models
 - 4, 4, 4, 5, 5, 6 for 6-buttons modely
- The acoustic signal  indicates mode switching.
- Wait until the device is restarted automatically.

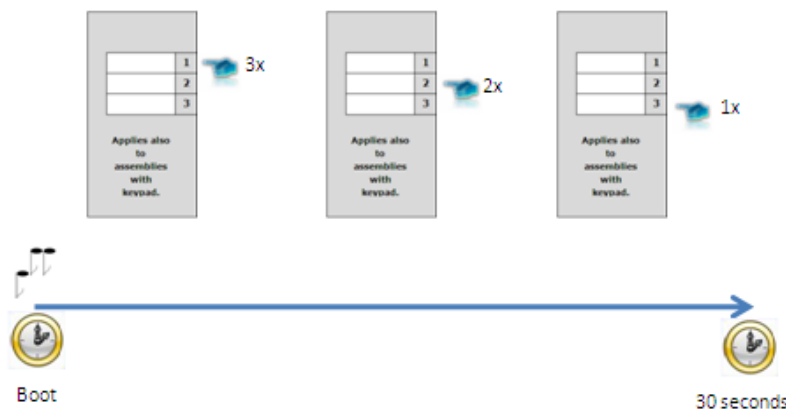


Figure 3.1 Switching to static IP address

Note: The 1, 1, 1, 2, 2, 3 sequence must be entered within 30 seconds after the first sound signal for security reasons. The inter-digit delay may be 2s at most.

The device will have the following network parameters after restart:



IP address: 192.168.1.100

Network mask: 255.255.255.0

Default gateway: 192.168.1.1

Dynamic IP Address Setting

Follow the instructions below to enable automatic getting of network parameters from the DHCP server:

- Connect 2N[®] Helios IP Vario to the power supply (or, disconnect and reconnect it if already connected).
- Wait for the first acoustic signal .
- Press following buttons sequentially:
 - 2, 1, 1, 2, 2, 3 for 3-buttons models
 - 5, 4, 4, 5, 5, 6 for 6-buttons modely
- The acoustic signal  indicates mode switching.
- Wait until the device is restarted automatically.

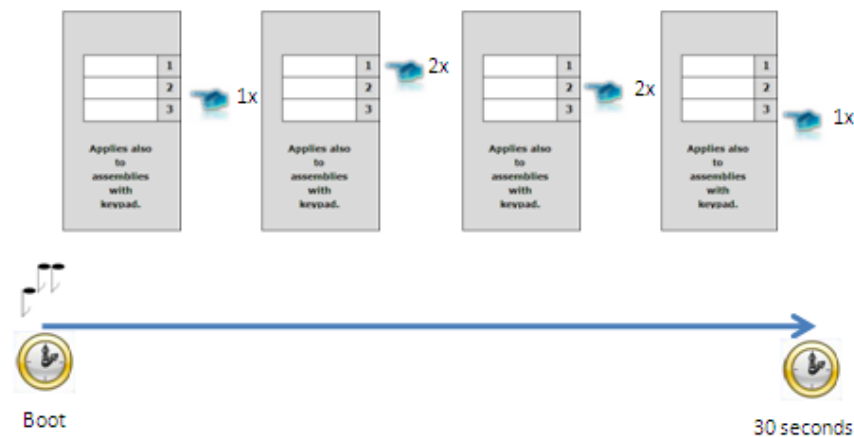


Figure 3.2 Switching to dynamic IP address

Note: The 2, 1, 1, 2, 2, 3 sequence must be entered within 30 seconds after the first sound signal for security reasons. The inter-digit delay may be 2s at most.

2N[®] Helios IP Vario gets the IP address upon restart only if the DHCP server is configured properly.

Mode Switching with 1-Button Models

In case your 2N® Helios IP Vario device is equipped with 1 button, you can switch the modes using one button only.

- Connect 2N® Helios IP Vario to the power supply (or, disconnect and reconnect it if already connected).
- Wait for the first acoustic signal 🗣️.
- Press button 1 15 times.
- The acoustic signal 🗣️🗣️🗣️ indicates mode switching.
- Wait until the device is restarted automatically.

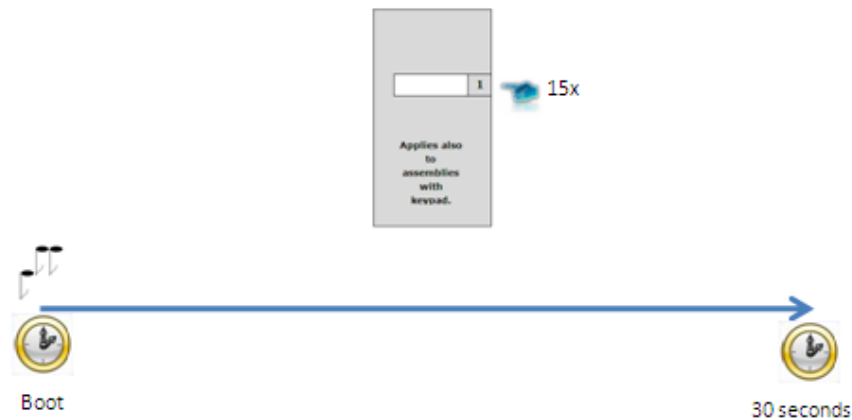


Figure 3.3 Switching between static and dynamic IP address

Note: The 15 times 1 sequence must be entered within 30 seconds after the first sound signal for security reasons. The inter-digit delay may be 2s at most.

The static IP address mode will be switched into the dynamic IP address mode and vice versa upon restart.

3.2 Intercomm Control as Viewed by External User

This section described the 2N[®] Helios IP Vario control as viewed by an external user (guest).

Quick Dialling Buttons

By pushing a quick dialling button on the basic unit you can call to positions 1,3...6 of the telephone directory (depending on the model type). With extending modules you can use up to 54 quick dialling options.

By pushing a quick dialling button you call the telephone number assigned to the selected telephone directory position. A call set-up is signalled by a long discontinuous tone or any other tone as defined in the attached PBX configuration.

By re-pushing the same button during calling or setting up you can hang up, hang up and call to another telephone number, or activate nothing as defined in the **Miscellaneous** subsection of 2N[®] Helios IP Configuration Manual.

You can also hang up the call any time by pushing **#** if the **Hang-up by #** button is enabled; refer to **Miscellaneous** subsection.

Calling to Telephone Directory Position

The 2N[®] Helios IP Vario telephone directory may contain up to 999 pre-programmed positions. You can use the quick dialling buttons for positions 1 to 54 only. To retrieve the remaining positions, use the numeric keypad if **Quick dialling using digits** is enabled; refer to the **Miscellaneous** subsection.

Procedure: Enter the position number using the numeric keypad (e.g. 05, 15, 200 – two digits at least and three digits at most) and push ***** for confirmation.

You can also hang up the call any time by pushing **#** if the **Hang-up by #** button is enabled; refer to **Miscellaneous** subsection.

Calling to User-Defined Telephone Number

If the **Telephone function enable** (refer to **Miscellaneous**) is selected, you can call the user-defined telephone number using the 2N[®] Helios IP Vario numeric keypad.

Procedure: Push *****. You can hear the continuous tone from the loudspeaker. Enter the telephone number using the numeric keypad and push ***** again for confirmation.

You can also hang up the call any time by pushing **#** if the **Hang-up by #** button is enabled; refer to **Miscellaneous** subsection.


Incoming Call Answer and Reject

If the automatic incoming call answer is disabled (refer to **Miscellaneous**), a call coming to 2N® Helios IP Vario is signalled with loud ringing. Push * to answer and # to reject the call.

Code Door Opening (Switch Activation)

2N® Helios IP Vario is equipped with a door unlocking switch. To activate the switch enter the valid code (see **Miscellaneous**) on the numeric keypad.




Procedure: Enter the lock 1 or lock 2 activating code using the numeric keypad and push *.

A valid code is signalled by a continuous switch activation (lock opening) signalling tone. An invalid code is announced by acoustic signalling -.

User Activation and Deactivation

You can activate or deactivate a user and define call routing to the user telephone numbers using the numeric keypad. For more details refer to the Telephone Directory subsection.




Procedure: Enter the user activation or deactivation code using the numeric keypad and push * for confirmation.

A valid code is announced by acoustic signalling  or  depending on the code type. An invalid code is announced by acoustic signalling -.

Profile Activation and Deactivation

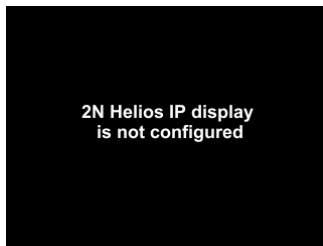
You can activate or deactivate a profile and define call routing to the telephone numbers assigned to the profile using the numeric keypad. For more details refer to the **Scheduler** subsection.

Procedure: Enter the profile activation or deactivation code using the numeric keypad and push * for confirmation.

A valid code is announced by acoustic signalling  or  depending on the code type. An invalid code is announced by acoustic signalling -.

3.3 Display-Equipped Intercom Viewed by External User

Until the display program is uploaded to 2N[®] Helios IP Vario, the display shows the following text: **2N[®] Helios IP display is not configured**; refer to the figure below. In this state, 2N[®] Helios IP behaves and is controlled like no-display models, see Display-Equipped Intercom Viewed by External User.



With the proper display configuration, the advertisement or electronic name tag mode is displayed upon the 2N[®] Helios IP Vario power on as pre-programmed.

The display-equipped 2N[®] Helios IP Vario model is controlled using the numeric keypad and quick dialling buttons. Buttons 2, 4, 6 and 8 are cursor keys in the telephone directory mode. Buttons 3 and 6 are functional keys and initiate the action displayed in the right-hand and left-hand screen corners.

Advertisement Mode

One or more images defined in the display program are displayed in the advertisement mode. To quit the ad mode and move to the electronic name tag mode, push any quick dialling button or numeric keypad key.

Electronic Name Tags

1, 2 or 4 name tags emulating the paper name tags can be displayed in the electronic name tag mode. Push one of the 1, 2, 4 and 5 quick dialling buttons to call the user assigned.



You can also enter the door lock opening codes and activate or deactivate a user or profile in this mode. For steps refer to the no-display 2N[®] Helios IP Vario subsection. Push the quick dialling button 6 to move to the Telephone directory mode and the * button to move to the **Calling to number** mode (only if the telephone function is enabled, see **Miscellaneous**).

Calling to Number

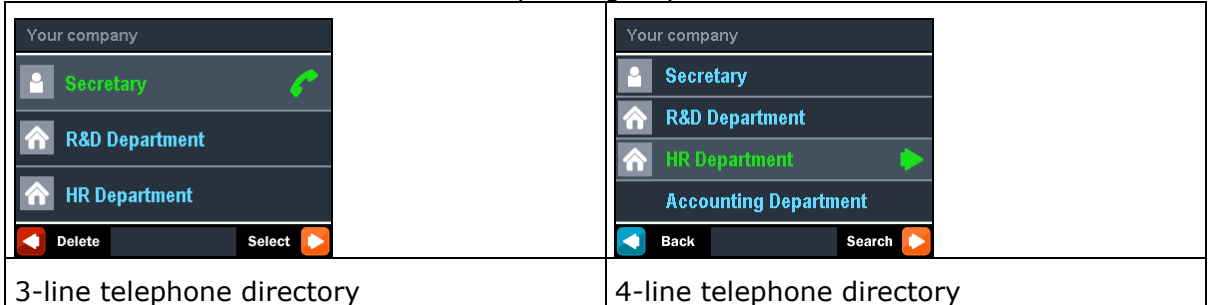
If the **Telephone function enable** is selected (see **Miscellaneous**), 2N® Helios IP Vario can be used for calling to selected telephone numbers in a standard way. Push * in the **Electronic name tag** mode to move to this mode.



Push the quick dialling button 3 or the # button to return to the electronic name tag mode. To dial and display the number to be called, use the numeric keypad and push * for confirmation. Push the quick dialling button 6 to delete and re-enter the last-dialled number if necessary.

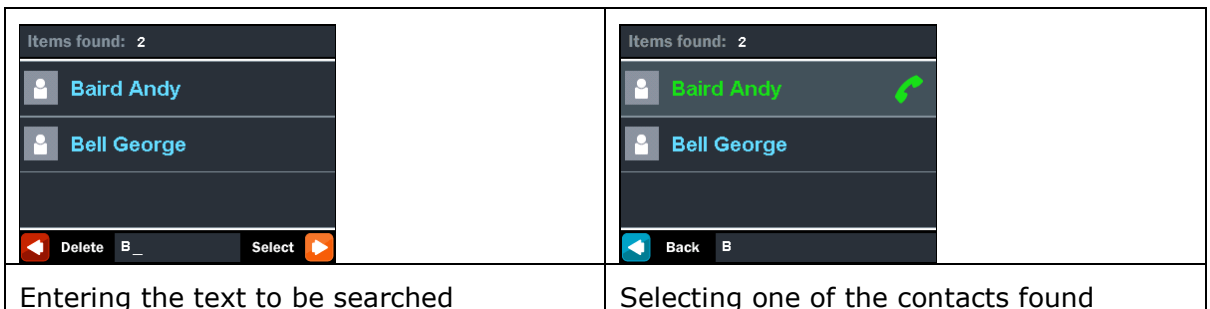
Telephone Directory

A structured telephone directory as defined by the display program is displayed in the telephone directory mode. To browse through the telephone directory use the numeric keypad arrow keys (i.e. keys 2, 4, 6 and 8). Use the up and down arrows to move between the items. Push the right arrow to establish a call or move to a subgroup. The * key and quick dialling buttons 4 and 5 have the same function as the right arrow. Use the left arrow to return to the superior group.



You can also use the telephone directory for retrieving contacts. Push the quick dialling button 6 to switch on the phone directory searching mode.

To retrieve a text, use the numeric keypad. The text to be searched is displayed in the centre of the status line. To delete the last character push the quick dialling button 3.











The text string is retrieved on the current level and all sublevels of the telephone directory. The count of contacts found is displayed on the top line. The first 3 (or 4) found contacts are displayed in the central part of the window.

To browse through the contacts found and select the required one, push the quick dialling button 6, thus recovering the arrow function of the numeric keypad.

Status Information

In addition to the above described modes, the 2N® Helios IP Vario display indicates various device statuses:

 <p>Call set-up...</p> <p>◀ Hang up</p>	 <p>Ringing...</p> <p>◀ Hang up</p>	 <p>Connected...</p> <p>◀ Hang up</p>
Call being set up	Ringing – outgoing call	Call connected
 <p>Call set-up failure</p> <p>◀ Hang up</p>	 <p>No response</p> <p>◀ Back</p>	 <p>Hung up</p> <p>◀ Back</p>
Call set-up failure	No response	Call terminated
 <p>Incoming call...</p> <p>◀ Back</p>	 <p>Door opened...</p> <p>◀ Back</p>	
Incoming call	Door opened/unlocked	

3.4 Intercom Control as Viewed by Internal User

This section describes the 2N[®] Helios IP Vario control as viewed by an internal user.

Receiving of 2N[®] Helios IP Vario Calls

Incoming calls from 2N[®] Helios IP Vario can be received like any other call. You can open the lock and activate or deactivate a user or profile during the call using your telephone numeric keypad. The call duration is limited to avoid unintentional 2N[®] Helios IP Vario line blocking. Use the Call time limit parameter to set the maximum call duration (refer to **Miscellaneous**). To prolong a call push the # button on your telephone any time. A short beep 10 s before the call end signals an automatic all termination.



Calling to 2N[®] Helios IP Vario

2N[®] Helios IP Vario allows to answer an incoming call too. To set the required parameters use the Incoming calls item, refer to **Miscellaneous**.

Code Door Opening (Switch Activation)

2N[®] Helios IP Vario is equipped with a door unlocking switch. To activate the switch enter the valid code (see **Miscellaneous**) on the numeric keypad.




Procedure: Enter the lock 1 or lock 2 activating code using your telephone numeric keypad and push * (confirmation is unnecessary if the Lock code without confirmation option is selected, refer to **Miscellaneous**).

A valid code is announced by acoustic signalling . An invalid code is announced by acoustic signalling .

User Activation and Deactivation

You can activate or deactivate a user and define call routing to the user telephone numbers using the numeric keypad. For more details refer to the Telephone Directory subsection.




Procedure: Enter the user activation or deactivation code using the numeric keypad and push * for confirmation.

A valid code is announced by acoustic signalling  or  depending on the code type. An invalid code is announced by acoustic signalling .

Profile Activation and Deactivation

You can activate or deactivate a profile and define call routing to the telephone numbers assigned to the profile using the numeric keypad. For more details refer to the Scheduler subsection.

Procedure: Enter the profile activation or deactivation code using the numeric keypad and push * for confirmation.

A valid code is announced by acoustic signalling  or  depending on the code type. An invalid code is announced by acoustic signalling .

3.5 Maintenance

A frequent use makes the device surfaces, especially the keyboard, dirty. Use a piece of soft cloth dampened with clean water to remove the dirt. You are recommended to follow the instructions below while cleaning:

- Do not use aggressive detergents (such as sand or strong surfactants).
- Clean at dry weather to make penetrated water, if any, dry up quickly.

5

Technical Parameters

This section describes the technical parameters of the product.

4.1 Technical Parameters

Signalling protocol	SIP (UDP)
Buttons	
Button design	Stainless-steel push buttons
Count of buttons	1, 3 or 6
Button extension	up to 54 buttons
Numerical keypad	optional
Audio	
Volume control	Adjustable
Full duplex	Yes (AEC)
Audio stream	
Protocols	RTP/RTSP
Codecs	G.711, G.729
Camera	
Sensor	1/4" colour CMOS
Resolution	640 (H) x 480 (V)
Picture frequency	Up to 30 snaps/s
Sensitivity	1.9 V/lux-sec (550nm)
Viewing angle	55° (H), 39° (V)
Infrared illumination	Yes
Video stream	
Protocols	RTP/RTSP/HTTP
Codecs	H.263+, H.264, MPEG-4, M-JPEG
IP camera function	Yes
Interface	
Power supply	12V ±15%/1A DC or PoE
PoE	PoE 802.3af (Class 0 - 12.95W)
LAN	10/100BASE-TX s Auto-MDIX
Recommended cabling	Cat-5e or higher
Passive switch	NO and NC contacts, up to 30V/1A AC/DC
Active switch output	12V/900mA DC
RFID card reader	
Supported cards	optional EM-40XX (125Khz) HID Proximity (125kHz, 26bit)

Mechanical properties

Working temperature	-20°C to 55°C
Working relative humidity	10% - 95% (non-condensing)
Storing temperature	-40°C to 70°C
Dimensions	210x100x29 mm
Weight	500g
Covering level	IP44, IP53 when the roof is used (see Mounting Accessories)



Declaration of Conformity

2N TELEKOMUNIKACE a.s. hereby declares that this product complies with all basic requirements and other relevant provisions of the 1999/5/EC directive. For the full wording of the Declaration of Conformity see www.2n.cz.

Industry Canada

This Class B digital apparatus complies with Canadian ICES-003.

Cet appareil numérique de la classe B est conforme à la norme NMB-003 du Canada.



This device complies with part 15 of the FCC Rules. Operation is subject to the following two conditions: (1) This device may not cause harmful interference, and (2) this device must accept any interference received, including interference that may cause undesired operation.



Note

- This equipment has been tested and found to comply with the limits for a Class B digital device, pursuant to part 15 of the FCC Rules. These limits are designed to provide reasonable protection against harmful interference in a residential installation. This equipment generates, uses and can radiate radio frequency energy and, if not installed and used in accordance with the instructions, may cause harmful interference to radio communications. However, there is no guarantee that interference will not occur in a particular installation. If this equipment does cause harmful interference to radio or television reception, which can be determined by turning the equipment off and on, the user is encouraged to try to correct the interference by one or more of the following measures:
 - Reorient or relocate the receiving antenna
 - Increase the separation between the equipment and receiver
 - Connect the equipment into an outlet on a circuit different from that to which the receiver is connected
 - Consult the dealer or an experienced radio/TV technician for help.



Caution

- Changes or modifications to this unit not expressly approved by the party responsible for compliance could void the user's authority to operate this equipment.
- Always use the product for the purpose it was designed and manufactured for, in compliance herewith.
- The manufacturer reserves the right to modify the product in order to improve its qualities.
- This device contains no environmentally harmful components. When the product's service life is exhausted and you would like to dispose of it please do so in accordance with applicable legal regulations.

6

Supplementary Information

This section provides supplementary information of the product.

Here is what you can find in this section:

- Regulations and Directives
- List of Figures
- List of Abbreviations

5.1 Regulations and Directives

2N[®] Helios IP Vario conforms to the following directives and regulations:

- Act No. 22/1997 Coll. of January 24, 1997 on technical requirements of products and amendments to some laws
- Directive 1999/5/EC of the European Parliament and of the Council, of 9 March 1999 – on radio equipment and telecommunications terminal equipment and the mutual recognition of their conformity
- Governmental Regulation No. 426/2000 Coll. on technical requirements of radio and telecommunications terminal equipment
- Directive 2006/95/EC of the European Parliament and of the Council of 12 December 2006 on the harmonisation of the laws of Member States relating to electrical equipment designed for use within certain voltage limits
- Governmental Regulation No. 17/2003 Coll. on technical requirements of low voltage electrical equipment
- Directive 2004/108/EC of the Council of 15 December 2004 on the harmonisation of the laws of Member States relating to electromagnetic compatibility
- Governmental Regulation No. 616/2006 Coll. on technical requirements of products in terms of electromagnetic compatibility
- Directive 2011/65/EU of the European Parliament and of the Council of 8 June 2011 on the restriction of the use of certain hazardous substances in electrical and electronic equipment
- Regulation (EC) No. 1907/2006 of the European Parliament and of the Council of 18 December 2006 concerning the Registration, Evaluation, Authorisation and Restriction of Chemicals (REACH), establishing a European Chemicals Agency, amending Directive 1999/45/EC and repealing Council Regulation (EEC) No. 793/93 and Commission Regulation (EC) No. 1488/94 as well as Council Directive 76/769/EEC and Commission Directives 91/155/EEC, 93/67/EEC, 93/105/EC and 2000/21/EC
- Directive 2002/96/EC of the European Parliament and of the Council of 27 January 2003 on waste electrical and electronic equipment

5.2 General Instructions and Cautions

Please read this User Manual carefully before using the product. Follow all instructions and recommendations included herein.

Any use of the product that is in contradiction with the instructions provided herein may result in malfunction, damage or destruction of the product.

The manufacturer shall not be liable and responsible for any damage incurred as a result of a use of the product other than that included herein, namely undue application and disobedience of the recommendations and warnings in contradiction herewith.

Any use or connection of the product other than those included herein shall be considered undue and the manufacturer shall not be liable for any consequences arisen as a result of such misconduct.

Moreover, the manufacturer shall not be liable for any damage or destruction of the product incurred as a result of misplacement, incompetent installation and/or undue operation and use of the product in contradiction herewith.

The manufacturer assumes no responsibility for any malfunction, damage or destruction of the product caused by incompetent replacement of parts or due to the use of reproduction parts or components.

The manufacturer shall not be liable and responsible for any loss or damage incurred as a result of a natural disaster or any other unfavourable natural condition.

The manufacturer shall not be held liable for any damage of the product arising during the shipping thereof.

The manufacturer shall not make any warrant with regard to data loss or damage.

The manufacturer shall not be liable and responsible for any direct or indirect damage incurred as a result of a use of the product in contradiction herewith or a failure of the product due to a use in contradiction herewith.

All applicable legal regulations concerning the product's installation and use as well as provisions of technical standards on electric installations have to be obeyed. The manufacturer shall not be liable and responsible for damage or destruction of the product or damage incurred by the consumer in case the product is used and handled contrary to the said regulations and provisions.

The consumer shall, at its own expense, obtain software protection of the product. The manufacturer shall not be held liable and responsible for any damage incurred as a result of the use of deficient or substandard security software.

The consumer shall, without delay, change the access password for the product after installation. The manufacturer shall not be held liable or responsible for any damage incurred by the consumer in connection with the use of the original password.

The manufacturer also assumes no responsibility for additional costs incurred by the consumer as a result of making calls using a line with an increased tariff.

Electric Waste and Used Battery Pack Handling



Do not place used electric devices and battery packs into municipal waste containers. An undue disposal thereof might impair the environment!

Deliver your expired electric appliances and battery packs removed from them to dedicated dumpsites or containers or give them back to the dealer or manufacturer for environmental-friendly disposal. The dealer or manufacturer shall take the product back free of charge and without requiring another purchase. Make sure that the devices to be disposed of are complete.

Do not throw battery packs into fire. Battery packs may not be taken into parts or short-circuited either.

5.3 List of Figures

Figure 2.1	Hole Drilling.....	18
Figure 2.2	Cover Removing	19
Figure 2.3	Plastic Cover Removing	19
Figure 2.4	Multiple-Module Assembly.....	19
Figure 2.5	Roof Mounting.....	20
Figure 2.6	Wall Mounting	20
Figure 2.7	Cabling.....	21
Figure 2.8	Name Plate Removing.....	21
Figure 2.9	Insert Removing.....	21
Figure 2.10	Label Inserting	21
Figure 2.11	Description of 2N [®] Helios IP Vario Connectors, PCB Version 530v2	24
Figure 2.12	Description of 2N [®] Helios IP Vario Connectors, PCB Versions 535v1, 535v2.....	25
Figure 2.14	Resetting Procedure – Display Model	30
Figure 2.15	Connection of One-Row-Button Extending Modules	34
Figure 2.16	Connection of Two-Button-Row Extending Module.....	35
Figure 3.1	Switching to static IP address.....	40
Figure 3.2	Switching to dynamic IP address.....	41
Figure 3.3	Switching between static and dynamic IP address.....	42

5.4 List of Tables

Table 2.1	Terminal Block Connections	27
Table 2.2	Terminal Block Connection for Electric Lock	27
Table 2.3	Terminal Block Connection for Power Adapter	28
Table 2.4	Connection of Configuration Connector Jumpers.....	29
Table 2.5	Configuration Jumpers on Display Connector	30
Table 2.6	Optional 2N [®] Helios IP Vario Extension.....	34



2N TELEKOMUNIKACE a.s.

Modřanská 621, 143 01 Prague 4, Czech Republic

Tel.: +420 261 301 500, Fax: +420 261 301 599

E-mail: sales@2n.cz

Web: www.2n.cz