

***2ENTRY* Helios**  
**Door Entry System**

**User and Service Manual**

**Version 2.1**

## ***Dear customer,***

*We congratulate you on having purchased the **2ENTRY Helios** door communicator, which is the successor to the popular product 2N<sup>®</sup> ENTRYCOM. We hope you will fully enjoy using this new product for a long time to come.*

### **Merits of the Product**

1. Exclusive design, – high-grade stainless steel finish.
2. Slim line design – no cutting into a supporting wall is required.
3. Exclusive long-life white illumination – LEDs.
4. New waterproof design.
5. Buttons have no mechanical parts – long service life.
6. Up to 16 buttons per unit.
7. Optional equipment – camera, display, etc.
8. Increased protection through Vandal Resistant panel.
9. Electronic volume and Handsfree control – no need to open the cover.
10. Ringing tone detection – hangs up automatically after a defined amount of rings.
11. Voice menu based programming.

### **List of Manual/Product Changes**

| Version | Changes   |
|---------|---|
| 2.0     | <i>A new version of the communicator firmware released in April 2007.</i><br>Marking: <b>FW:07-02-22</b> <ul style="list-style-type: none"><li>• New voice functions – new parameters 974, 976 and 977</li><li>• Double-tone detection</li><li>• New implicit value of parameter 951</li><li>• Antivandal assortment upgraded</li></ul> |

|   |           |
|---|-----------|
| <b>1. FEATURES</b> .....  | <b>4</b>  |
| 1.1. <i>OPTIONAL ACCESSORIES:</i> .....                           | 4         |
| <b>2. PURPOSE</b> .....   | <b>5</b>  |
| <b>3. PRODUCT MIX</b> .....                                       | <b>6</b>  |
| 3.1. <i>BASIC AND EXTENDER UNITS</i> .....                        | 6         |
| 3.2. <i>INSTALLATION ACCESSORIES</i> .....                        | 7         |
| 3.3. <i>INCREASED PROTECTION ACCESSORIES</i> .....                | 8         |
| 3.4. <i>GSM AD VOIP CONNECTION ACCESSORIES</i> .....              | 8         |
| 3.5. <i>DISPLAY</i> .....   | 8         |
| 3.6. <i>VIDEO ACCESSORIES</i> .....                               | 9         |
| 3.7. <i>ELECTRIC LOCKS</i> .....                                  | 9         |
| 3.8. <i>OTHER ACCESSORIES</i> .....                               | 9         |
| <b>4. TERMINOLOGY</b> .....                                       | <b>10</b> |
| <b>5. FUNCTION DESCRIPTION</b> .....                              | <b>11</b> |
| 5.1. <i>FROM EXTERNAL USER'S VIEW (VISITOR)</i> .....             | 11        |
| 5.2. <i>FUNCTION DESCRIPTION – NUMERICAL KEYPAD UNITS</i> .....   | 11        |
| 5.3. <i>FROM INTERNAL USER'S VIEW (SURVEY OF FUNCTIONS)</i> ..... | 12        |
| 5.4. <i>SIGNALS OVERVIEW</i> .....                                | 13        |
| 5.5. <i>MESSAGE OVERVIEW</i> .....                                | 13        |
| 5.6. <i>CALL TERMINATION OPTIONS - SUMMARY</i> .....              | 14        |
| 5.7. <i>CODE LOCK</i> .....                                       | 14        |
| 5.8. <i>TRADITIONAL BUTTON TELEPHONE</i> .....                    | 14        |
| 5.9. <i>DTMF TRANSMISSION DURING OUTGOING CALL</i> .....          | 15        |
| 5.10. <i>BUTTONS SUBSTITUTION</i> .....                           | 15        |
| 5.11. <i>KEYPAD OPERATION INSTRUCTIONS - SUMMARY</i> .....        | 15        |
| <b>6. INSTALLATION INSTRUCTIONS</b> .....                         | <b>18</b> |
| 6.1. <i>START UP</i> .....  | 18        |
| 6.2. <i>MECHANICAL MOUNTING</i> .....                             | 18        |
| 6.3. <i>BUTTONS LABELS – INSERTION, REPLACEMENT</i> .....         | 20        |
| <b>7. ELECTRICAL INSTALLATION</b> .....                           | <b>21</b> |
| 7.1. <i>COMMON INSTALATION</i> .....                              | 24        |
| 7.2. <i>CAMERA INSTALLATION</i> .....                             | 27        |
| 7.3. <i>DISPLAY INSTALLATION</i> .....                            | 27        |
| 7.4. <i>CONNECTION OF EXTENDER UNITS</i> .....                    | 28        |
| <b>8. PROGRAMMING</b> .....                                       | <b>31</b> |
| <b>9. FULL PARAMETER CHART</b> .....                              | <b>33</b> |
| <b>10. MAINTENANCE</b> .....                                      | <b>37</b> |
| <b>11. SECTION FOR ADVANCED USERS</b> .....                       | <b>37</b> |
| 11.1. <i>AUTOMATIC MULTIPLE NUMBER DIALLING</i> .....             | 37        |
| 11.2. <i>ARRIVAL/DEPARTURE, DAY/NIGHT MODES</i> .....             | 40        |
| <b>12. TECHNICAL PARAMETERS</b> .....                             | <b>41</b> |
| 12.1. <i>TELEPHONE PARAMETERS</i> .....                           | 41        |
| 12.2. <i>OTHER PARAMETERS</i> .....                               | 41        |

# 1. Features

- Operates on any analogue telephone line
- Telephone-controlled electronic lock switch
- Exclusive white button backlight – white LEDs
- Modularity – up to 54 buttons + keypad
- Applicable as a standard telephone and code lock (keypad version)
- Flat design – installation no need to cut into mounting surface
- Water resistant:
  - Hermetically sealed buttons
  - Separate electronics from name plates
- Telephone-based programming
- Detection of all standard tones
- Stable line power feeding
- High acoustic quality
- Electronic volume and Handsfree control – no need to open cover
- Special functions includes automatic dialling of multiple numbers, silent dialling, departure/arrival, day/night mode, second switch delay

## 1.1. Optional Accessories:

- **Vandal resistant panel**
  - New resistant metal cover for better protection against vandalism.
  - Flush mounting steel box included in the cover price.
  - Can be purchased and installed as an option.
- **Additional (second) switch**
  - With switching and breaking contact (relay).
  - Time-unlimited switch option.
- **Camera unit**
  - Can be installed into any basic unit (incl. Vandal Resistant).
  - High-quality colour CCD.
  - Wide angle, adjustable direction.
- **Proximity reader unit** – can be installed into the basic unit as an option.
- **Display module**
  - Can be installed into any basic unit as an option.
  - Graphic LCD, backlight with automatic brightness regulation.
  - Up to 1,000 characters including text and graphics.
  - PC configuration, USB interface.

## 2. Purpose

The **2ENTRY Helios** door communicator replaces a traditional door entry system which would traditionally have to have a whole cabled distribution infrastructure behind it. The connectivity of the unit is flexible in that as standard the unit can connect to any telephone system via either an analogue extension or trunk port. The Helios unit can also connect to any network provider's analogue telephone line.

**2ENTRY Helios** is also easy to use – just press the desired call button and the **Helios unit** will automatically “dial” the number pre-stored in the respective memory. The number of buttons is flexible as it is a modular unit.

**2ENTRY Helios** also has a switch that controls the electric lock by using any telephones keypad (by tone-dialling the password).

In addition to the buttons, you can use a numerical keypad, which is used as a code lock. Using the keypad, you can operate the device as a button telephone and dial the required numbers directly or retrieve them from any of the 54 memories available. You can disable non-desired functions.

**2ENTRY Helios** provides improved and feature rich options compared with standard door entry systems, this is because you can make use of functions such as call redirection if not answered, or have a day and night mode set up for automatic redirection of the call for instance after normal working hours.

The **2ENTRY Helios** parameters meet all technical requirements mandatory for devices designed for the PSTN (public switched telephone network) connection.

### 3. Product Mix

#### 3.1. Basic and Extender Units

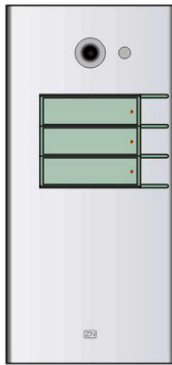

**Part No. 9135130E**  
Basic unit  
3 buttons



**Part No. 9135130KE**  
Basic unit  
3 buttons + keypad

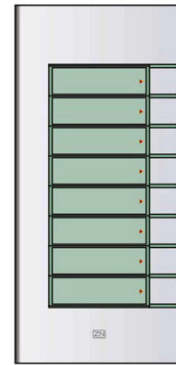

**Part No. 9135181E**  
Extender unit  
8 buttons

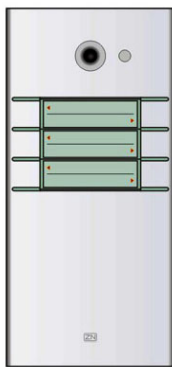

**Part No. 9135160E**  
Basic unit  
3x2 buttons

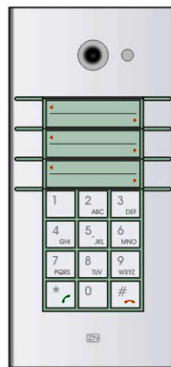

**Part No. 9135160KE**  
Basic unit  
3x2 buttons + keypad

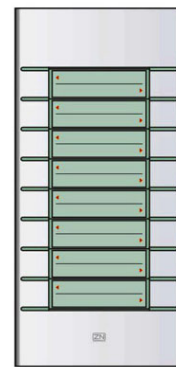

**Part No. 913582E**  
Extender unit  
8x2 buttons

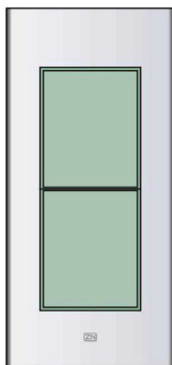

**Part No. 9135310E**  
Info panel

A backlit buttonless panel used for the telephone directory, house number, etc.

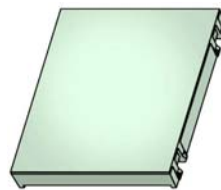

**Part No. 9135311E**  
Info panel – name plate

Replaces four name plates with one cover. Enables the use of one half of the extender unit for the telephone directory, opening hours, etc.

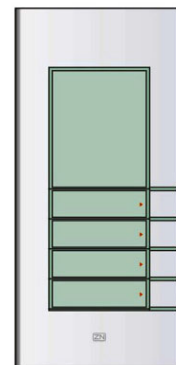

**Part No. 9135320E**  
Info panel + 4 bell buttons

An independent product not connected to the telephone line. Combines four bell buttons and space for the company or department name, opening hours, etc.

**All the above-mentioned units can be wall mounted without requiring any additional accessories. All the basic units can be complemented with a camera, proximity reader (see later) and display (under preparation). All units can be made more resistant using the Vandal resistant cover. Additional accessories (see later) are needed for outdoor flush mounting purposes.**

### 3.2. Installation Accessories

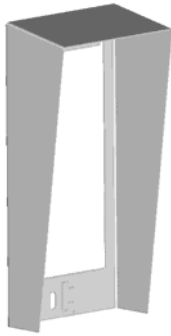

**Part No. 9135331E**  
 Wall mounting roof  
 for 1 module  
**Dimensions (WxHxD):**  
 103 x 218 x 60 mm



**Part No. 9135351E**  
 Flush mounting box  
 with 1-module frame  
**Dimensions:**  
 125 x 235 x 46 mm  
**Hole:**  
 110 x 220 x 50+- 5 mm

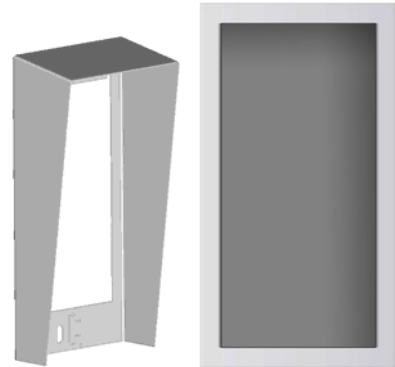

**Part No. 9135361E**  
 Flush mounting box with 1-module roof  
**Roof dimensions (WxHxD) :**  
 129 x 240 x 41 mm  
**Hole (WxHxD):**  
 110 x 220 x 50mm +- 5mm

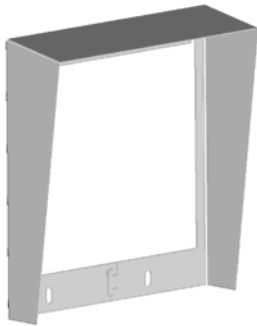

**Part No. 9135332E**  
 Wall mounting roof  
 for 2 modules  
**Dimensions (WxHxD):**  
 203 x 218 x 60 mm



**Part No. 9135352E**  
 Flush mounting box  
 with 2-module frame  
**Dimensions:**  
 225 x 235 x 46 mm  
**Hole:**  
 210 x 220 x 50+- 5 mm



**Part No. 9135362E**  
 Flush mounting box with 2-module roof  
**Roof dimensions (WxHxD) :**  
 229 x 240 x 41 mm  
**Hole (WxHxD):**  
 210 x 220 x 50mm +- 5mm

All mounting accessories are made from stainless steel particularly necessary for outdoor applications unless there is suitable weather protection. The flush mounting frame box (without roof) enables installation of the **Helios unit** indoors so that it does not protrude from the wall (up to 1 mm).

### 3.3. Increased Protection Accessories

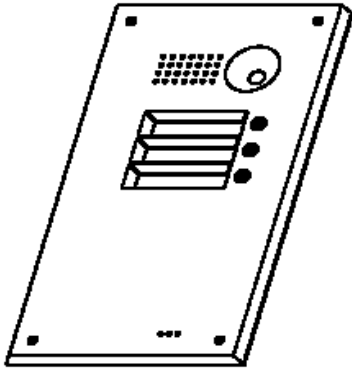

Part No. 9135511E  
Vandal resistant cover for basic unit + Flush mounting box \*)

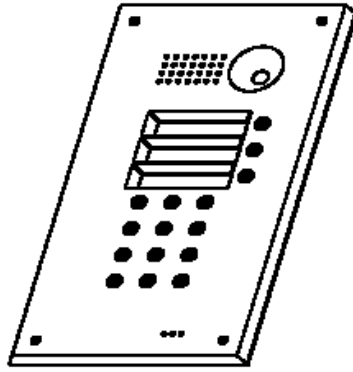

Part No. 9135511KE  
Vandal resistant cover for basic unit with keypad + Flush mounting box \*)

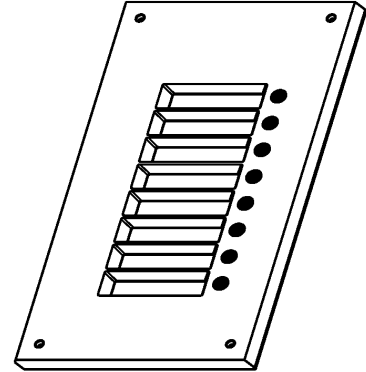

Part No. 9135515E  
Vandal resistant cover for one extension unit + Flush mounting box \*)

\*) Attention! This box is not 9135351E !!! It is a special box only for Vandal resistant covers.

The purpose of the covers shown above is to make the basic units or sets with up to 11 buttons as weather and vandal resistant as possible. More extensive sets can be tailor-made. Remember that the Vandal resistant set must always be flush mounted and needs no roof even if used outdoors.

### 3.4. GSM ad VOIP connection accessories



GSM gateway Easygate,  
501303E



Analog/VoIP gateway,  
Part No. 9134171E

### 3.5. Display

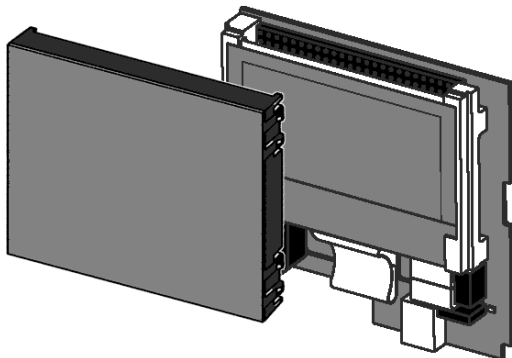

Black & white, Graphic LCD 128 x 64 pixels, white backlight, up to 1000 characters, configurable via USB interface, can be installed into any basic unit as an option.

Part No. 9135240



### 3.6. Video Accessories



**Part No. 9135210E**  
In-built colour CCD camera

PAL, resolution 420 TV rows, sensitivity 2 lux  
The camera can be built in any basic unit. In the case of poor light, the camera switches into the monochrome mode automatically.  
Supplementary infrared light.  
Horizontal/vertical tilting option.



**Part No. 9134147E**  
7" colour LCD monitor (TFT)

The selected model features a composite video signal input with high sensitivity for long cabling runs. Vivid colours, wide-angle display option, in-built TV set. The right to change the design is reserved.



**Part No. 9134145E**  
MPEG4 LAN video server  
Video records can be observed by anybody's PC via the LAN, no SW installation is needed. Serves up to 10 PCs at the same time. The MPEG-4 compression ensures the network load is approximately 10 times lower than uncompressed. The Internet can also be used to watch the video.. Quality / data flow control option. Free SW for intelligent recording of the video record into a PC (includes movement detection).

### 3.7. Electric Locks



**Part No. 932070E**  
BEFO 1211 12V / 600 mA



**Part No. 932080E**  
BEFO 1221  
with torque pin



**Part No. 932090E**  
BEFO 1211MB  
with mechanical blocking

### 3.8. Other Accessories



**Part No. 9135250E**  
Additional switch

Switching and breaking contact option, time-unlimited switching, up to 48 V / 2A.



**Part No. 91341481E**  
12V / 2A adapter

A stabilised power supply must be used if a camera is installed. It can also feed the lock and backlight.



**Part No. 9134148E**  
SIEMENS® adapter  
This is required when connecting to a Siemens HiPath Telephone system



**Part No. 932928E**  
12V Transformer



**Part No. 9135301E**  
name plate



**Part No. 9135302E**  
double-button name plate

## 4. Terminology

**Line pick-up/seizure/off-hook** – call start, line locked, busy.

**Line hang-up/clear** – call end, handset hang-up.

**DTMF** – dual tone multi-frequency signalling.

**PSTN** – public switched telephone network.

**Outgoing call** – **Helios**-telephone connection made, e.g. by a pressing a button.

**Incoming call** – telephone-**Helios** connection.

**Programming mode** – **Helios** programming mode accessible from by dialling into the intercom only.

**Code lock** – mode for entering the password for switch 1 or 2 activation using a numerical keypad.

**Telephone mode** – you can make a call, dial a number and hang up using the numerical keypad.

**DTMF transmission during call** – for outgoing calls only, numbers are tone-dialled by a numerical keypad button.

**Button substitution** – the numerical keypad can be used instead of a number pre-stored under a button memory.

## 5. Function Description

### 5.1. From External User's View (Visitor)

Like normal Doorbells, **Helios** buttons are provided with labels the visitor finds the appropriate button (e.g. Mr. Smith) and presses it this activates **Helios** to then dial the number pre-programmed for under that button, the visitor can then hear the ringing tone from the loudspeaker and the required (Mr. Smith's in this case) telephone is ringing. If the Helios unit is connected to a telephone system you may be able to tag the port that Helios is connected to so that you can see on the ringing phone that it is the **Helios** that is calling. When the called party answers the call, the visitor and tenant can speak to each other and if an electric lock is connected to **Helios**, the called person can open the door by entering the correct password on the telephone keypad to activate the door or barrier. When the caller hangs up, **Helios** detects the PBX or analogue line tone and hangs up too. **Helios** also hangs up when it "hears" the busy tone or if the call takes more time than pre-programmed to connect. You can pre-program the amount of time that you have to speak into the microphone however when you are reaching the programmed time the unit gives a warning tone 10 seconds before hanging up so that the called party can extend the call if required.

#### **Notes:**

- If the visitor presses **another** button during the call, **Helios** hangs up for a few seconds before dialling the new number.
- If a button is pressed that has no number stored within it **Helios** picks up the line, sends a refusal tone (refer to the Signals Overview) and hangs up.
- If the visitor presses **the same** button during the call, **Helios** may hang up (can be programmed to stop this feature if required).
- The above mentioned rules are only applied if the **Automatic Multiple Number Dialling** mode is OFF. For this special mode refer to the Automatic Multiple Number Dialling section.

### 5.2. Function Description – Numerical Keypad Units

The **2ENTRY**<sup>®</sup> - **Helios** basic units, Part Nos. **9135130K** and **9135160K**, are equipped with a numerical keypad. The keypad provides a number of functions:

- **traditional code lock**
- **features as if a normal telephone set**
- **DTMF transmission during an outgoing call**
- **substitution of up to 54 buttons**

The keypad features a smart metal design and very favourable price to performance ratio. For the description of the functions from the user's view see below.

### 5.3. From Internal User's View (Survey of Functions)

- Calling to Helios

You call the appropriate extension and **Helios** makes the call and gives a confirmation tone after two rings (or as pre-programmed). Now you can speak and control the 2 switches, program **Helios** (see later), and listen to what is going on outside and speak to the calling party if desired..

- Opening door

**Helios** contains a switch to which an electric lock can be connected (not included in this pack). This switch can be telephone keypad controlled using a (digital) password in two ways as shown in the default password 00 example below:



or







The switch activation time can be programmed once the switch is enabled this will also automatically terminate the call in the next 30 seconds.

**Notes:**

- *If the Automatic Multiple Number Dialling with Confirmation or the Silent Automatic Multiple Number Dialling with Confirmation mode is selected and the password starts with digits 1 to 5, an asterisk must always be used.*
- **You Must** enter every digit in the password within five seconds (or as pre-programmed) to avoid **Helios** from hanging up.
- Switch 2 activation (light, e.g.):  
The second switch (if an additional switch is installed) can be controlled in the same way.
- Switch 2 synchronisation:  
Switch 2 can also be used to delay the opening of another door. Once the switch 2 delay timeout is programmed, the second switch is synchronised automatically with the first one, the delay being 1 – 25 seconds.
- Switch activation signalling (for both switches)  
After the correct password is entered, the switch is activated and you can hear the confirmation signal on your telephone. You can now speak (e.g. say: "The door is open") or listen (to the door-opening sound, etc.) until the switch is deactivated. Upon deactivation, you can hear the storing signal (see the Signals Overview).
- Call extension  
**Helios** beeps 10 seconds before the call end to extend the call by 30 seconds press  on your telephone (DTMF). You can use this function repeatedly. The visitor, however, cannot use this function!
- Programming  
The access to this mode is password-protected. For details refer to the Programming section. The voice menu considerably helps with programming the Helios unit. Having entered the programming mode, you can also alter any parameter and memory settings.

**Caution:** The above mentioned functions (except for calls to **Helios**) require a **tone-dialling** telephone set.

## 5.4. Signals Overview

| Signal  | Name         | Meaning  |
|---|--------------|--|
|  | Confirmation | <ul style="list-style-type: none"> <li>sent immediately after line seizure for incoming calls (can be heard by the calling party);</li> <li>signals switch activation (by DTMF) - can be heard by the person "at the other end" who activated the switch</li> </ul>  |
|  | Refusal      | <ul style="list-style-type: none"> <li>signals that a non-programmed button has been pressed;</li> <li>signals that an incorrect password has been entered on the keypad;</li> <li>can be heard from the loudspeaker after line connection (first connection signalling);</li> <li>signals an incoming call if <b>Helios</b> has not been programmed;</li> <li>When a disabled function has been entered from the keypad.</li> </ul> |
|  | Storing      | <ul style="list-style-type: none"> <li>Signals switch deactivation (if activated by DTMF).</li> </ul>  |
|  | Hang-up      | <ul style="list-style-type: none"> <li>Sent to notify that the call is terminated (in all cases).</li> </ul>   |
| Long continuous tone  |              | <ul style="list-style-type: none"> <li>signals that the unit is going through full initialisation or dialling memory or password clearing;</li> <li>Heard from the loudspeaker while the switch is activated by keypad.</li> </ul>   |
| "Attention, your call is being terminated"  |              | signals that the preset maximum call time will elapse within 10 seconds during outgoing and incoming calls   |
| "Wait, please"  |              | <ul style="list-style-type: none"> <li>Optional message during call establishing</li> </ul>  |
| "Communicator number ..... is calling"  |              | <ul style="list-style-type: none"> <li>Optional message for communicator identification</li> </ul>   |
| Voice menu  |              | In the programming mode.   |

## 5.5. Message overview

| Parameter value 976, 977 | Language order – Czech version | Message about a call termination  | Message about a call establishing |  |
|--------------------------|--------------------------------|---|-----------------------------------|--|
| 0                        | original signal                |  | Switched off !!!                  |  |
| 1*)                      | English                        | <b>Attention, your call is being terminated</b>                                     | <b>Wait, please</b>               | <b>Communicator number..... is calling</b> |
| 2                        | Czech                          | Pozor, končí hovor  | Čekejte, prosím                   | Volá komunikátor číslo .....               |
| 3                        | Slovak                         | .....   | .....                             | .....                                      |
| 4                        | German                         | .....   | .....                             | .....                                      |
| 5                        | Russian                        | .....   | .....                             | .....                                      |
| 6                        | Polish                         | .....   | .....                             | .....                                      |
| 7                        | Slovenian                      | .....   | .....                             | .....                                      |
| 8                        | Portuguese                     | .....   | .....                             | .....                                      |

\*) Initial value. *ATTENTION* – Czech version of the product has Czech language under number 1 and English is under number 2!

## 5.6. Call Termination Options - Summary

1. The busy or continuous tone \*) after the call end.
2. The ringing tone \*) after a predefined count of rings.
3. The subscriber “at the other end” pressed **#**.
4. The preset maximum call duration has elapsed.
5. 30 seconds after the switch use has elapsed.
6. A **Helios** button was pressed during the call.
7. The **#** keypad button was pressed during the call (can be disabled).

\*) The communicator is able to detect a permanent tone, busy tone and ringing tone even if the tone has two frequency components as in the UK, the U.S.A. (the so-called BTT tone) and in Canada. This new function does not require setting of any parameter. One of the tone components must be of 440 Hz.

## 5.7. Code Lock

The electronic lock connected to the **Helios** can not only be activated by the phone but also directly from the door using the keypad. In this mode, the keypad behaves like a standard code lock with the following features:



- Both switches can be controlled (if 2 connected)
- Password length - 1 to 16 digits;
- Up to 10 passwords per switch;
- Switch activation time - 1 to 9 seconds;
- Acoustic switch activation signalling – continuous tone.

The code lock uses the same passwords as the ones that have been defined for the telephone based switch control. Remember that the default passwords (**00** for switch 1 and **11** for switch 2) cannot be entered from the numerical keypad because they are notoriously known.

### Control

Enter the correct password and **X**. If the password is valid, a long tone is transmitted for a predefined time (5seconds by default). The corresponding switch is activated during this time. If the password is invalid, **Helios** sends a refusal signal.

## 5.8. Traditional Button Telephone

Any number can be “dialed” in this mode. To dial, press **X**, and to hang up use **#**. These keys are typically provided with pictograms  and . PSTN calls can be barred for a line in the PBX. The dialling type (tone, pulse) is selected in the programming mode. With pulse dialling, the **X** character initiates (upon off-hook) transition to tone dialling – like on any other telephone.

*Note: If this function is enabled, you can press **#** to hang up an outgoing call initiated by pressing a separate button.*

## 5.9. DTMF Transmission during Outgoing Call

This function enables the unit to transmit DTMF tones when the connection with one of the pre-programmed numbers has been established. It is used in combination with automatic information systems, voice mailboxes, etc., which ask the calling party to select a service using tone dialling. This function, however, does not allow you to call destinations other than the pre-programmed ones.

## 5.10. Buttons Substitution

This function is an analogy to memories in comfortable telephone sets. After two digits ranging between 01 and 54 (0 may not be omitted) are pressed, the call to the pre-programmed number is made. You can use **Helios** as if it had up to 54 separate buttons, which saves buying the extender units and space on the installations wall. The ideal solution is to use a few standard buttons for the most important speed dialling options e.g. Warden, Reception and then provide a list of pre-programmed options via the optional info panel that can be purchased.

### Admissible Keypad Function Combinations

All of the above mentioned 4 functions can be combined freely – each of them can be enabled or disabled separately as desired.

## 5.11. Keypad Operation Instructions - Summary

- **Door opening – code lock**  
Enter any valid password for switch 1 and .  
**Warning!** Password 00 may not be used!
- **Switch 2 activation:**  
Enter any valid password for switch 2 and .  
**Warning!** Password 11 may not be used!
- **Traditional button telephone**
  - gets **Helios** ready to dial a number.
  - ... Dials a number.
  - Transmits into tone dialling during pulse dialling.
  - Transmits a character in tone dialling.
  - Hangs up anytime during a call.
- **DTMF transmission during outgoing call**  
( of a single button, not in the telephone mode!)
  - ... - tone-dials a number.
  - The character is sent normally.
  - The character is sent normally.
- **Buttons substitution:**
  - 01...54 – the number that complies with the selected button (memory) is dialled after a timeout.
  - If an asterisk is pressed after number 01...54, the number is dialled immediately unless it is identical with the set password.

## Frequently Asked Questions Regarding Keypad Function

- **Can any of the switches be activated permanently?**  
Yes, the additional switch can be activated by one password and deactivated by another.
- **Is it possible to arrange for the switch to be activated during the whole call?**  
Yes, additional switch can do it.
- **Is it possible to use a single command to activate one switch first and the other later?**  
Yes, it is possible to use parameter 824, Switch 2 delay.
- **Can both the switches be activated at the same time?**  
While one switch is activated, the other can be activated by another password. You can also use parameter 824, Switch 2 delay, defining the shortest delay time possible (1second) and a sufficiently long switch activation time.
- **Can I use the code lock while another person is speaking through Helios?** Yes but this is not advisable as you should be aware that the password is private and could contravene security.
- **What happens when I press a number with no pre-programmed memory while the button replacing function is enabled?** The same as if you pressed a button that is not pre-programmed: **Helios** seizes the line, beeps refusal (refer to Signalling) and hangs up immediately.
- **What happens if a password is identical with the memory number while the code lock and button substituting functions are enabled?** The code lock function has the highest priority. If, for example, the password is 33 and you press **33\***, the switch is activated instantaneously. If you press **33** without an asterisk, the line is seized after a preset delay and the number from memory 33 is dialled.

## Password Selection Tips

- Tip 1:** Keyboard letters facilitate password remembering. For example, it is easier to remember a 9-letter word (e.g. crocodile) than a 9-digit number (276263453).
- Tip 2:** It is not recommended to use such passwords as 3333. This leads to a considerable wear and tear of one button and an unauthorised person may guess your password easily. It is ideal to employ all keys evenly, using several codes for different persons or groups.



### HELIOS Statuses and Available Operations

| Operation                                     |   | Hang-up | Outgoing call | Incoming call | Programming | Telephone mode |
|---|---|---------|---------------|---------------|-------------|----------------|
| Button pressing – new call                    |   | ✓       | x             | ---           | ---         | ✓              |
| Call extension - DTMF ☒                       |   | ---     | ✓             | ✓             | ---         | ✓              |
| Call termination - DTMF #                     |   | ---     | ✓             | ✓             | ✓           | ✓              |
| Hang-up upon continuous, busy or ringing tone |   | ---     | ✓             | ✓             | ✓           | ✓              |
| Switch activation – DTMF password             |   | ---     | x             | x             | ---         | x              |
| Programming start                             |   | ---     | ---           | ✓             | ---         | ---            |
| Keypad  | Switch activation – code lock             | x       | x1)           | ---           | ---         | ---            |
|   | DTMF into outgoing call                   | ---     | x             | ---           | ---         | ✓2)            |
|   | Button replacing (speed dial from memory) | x       | x1)           | ---           | ---         | ---            |
|   | Off-hook by key ☒ (into telephone mode)   | x       | ---           | ---           | ---         | ---            |
|   | Hang-up by key #                          | ---     | ✓1)           | ---           | ---         | ✓              |
|   | Hang-up by key ☒                          | ---     | ✓1)           | ---           | ---         | ---            |

#### Explanatory notes:

✓... Yes, always

x ... Yes if this function is programmed

1) This holds if DTMF is disabled during outgoing calls (the corresponding tone is transmitted in that case).

2) If pulse dialling is selected, it is possible to switch into tone dialling by pressing ☒ (but not vice versa!).

## 6. Installation Instructions

### 6.1. Start Up

Please check the contents of your delivery:

|  |       |
|--|-------|
| Basic unit                             | 1 pc  |
| This manual                            | 1 pc  |
| Inbus key 2/5                          | 1 pc  |
| Transparent name plate foil of size A5 | 1 pc  |
| Dowels                                 | 2 pcs |
| Screws                                 | 2 pcs |
| Substitute name plate                  | 1 pc  |

*Note: If you have bought a complete "packet", the delivery may contain additional items including instructions for use and lists of available parts.*

### 6.2. Mechanical Mounting

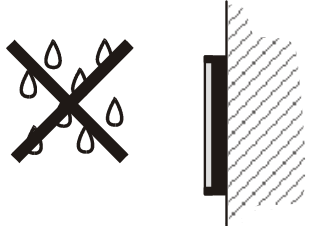
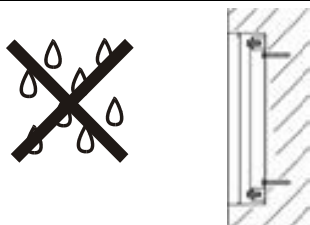
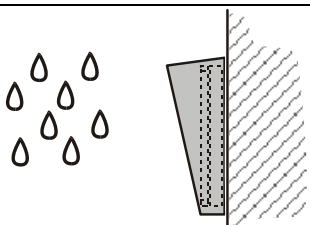
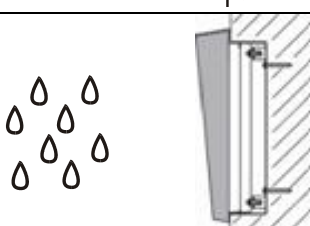
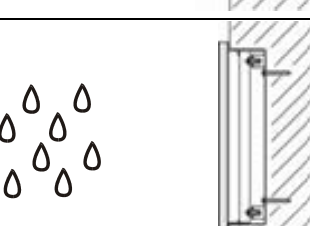
| Mounting Options       |   | What You Need for Mounting  |
|------------------------|---|---|
| Indoor wall mounting   |   | - <b>2ENTRY Helios</b> only   |
| Indoor flush mounting  |  | - <b>2ENTRY Helios</b><br>1-module flush mounting box with frame, Part No. <b>9135351E</b> , or<br>2-module flush mounting box with frame, Part No. <b>9135352E</b> |
| Outdoor wall mounting  |  | - <b>2ENTRY Helios</b><br>- 1-module wall-mounting roof Part No. <b>9135331E</b> , or<br>- 2-module wall-mounting roof Part No. <b>9135332E</b>                     |
| Outdoor flush mounting |  | - <b>2ENTRY Helios</b><br>- 1-module flush mounting box with roof Part No. <b>9135361E</b> , or<br>- 2-module flush mounting box with roof Part No. <b>9135362E</b> |
| Increased Protection   |  | - <b>2ENTRY Helios</b><br>- <i>Vandal Resistant cover with a box designed according to the set to be mounted</i>  |

### **Explanatory Notes to the Table Above:**

For the purpose hereof, **indoor environment means:**

- Interior space with low relative humidity, such as corridors, offices and other environmentally controlled rooms.
- Interior space where **moisture condenses** on walls **but in no case flows down the walls**, such as verandas, storing rooms, industrial facilities.
- Exterior space **sheltered against rain and water flowing down the walls**, such as shelters, passageways.

For the purpose hereof, **outdoor environment means:**

Environment, where a product is exposed to rain and / or **water flowing down** the walls, such as fences, external walls of buildings, etc.

#### **WARNING:**

The warranty does not cover failures and defects of the product arising as a result of improper installation (in conflict with these instructions). In addition, the manufacturer shall not be held liable for damage incurred through misappropriation from rooms that are accessible after the attached electric lock is activated. The product is not intended as an anti theft / entry device on its own only in combination with a classic safety lock.

### **Wall Mounting**

1. Drill holes using the **template**, inserted in the manual. Use the wall dowels attached.
2. With multiple module sets, connect the frames as shown in the figure. Place the basic unit on the left and extender units on the right. The interconnecting cable should be installed later!
3. Put the blanking modules on the unused side holes as shown in the figure.
4. If you are utilising a roof module, you should install it now.
5. Screw **Helios** onto the wall. Carry the supply cables (line, lock, power supply) through one of the holes into the basic unit frame.
6. If you use a roof module, fix its upper and side edges to the wall using silicone as shown in the figure.

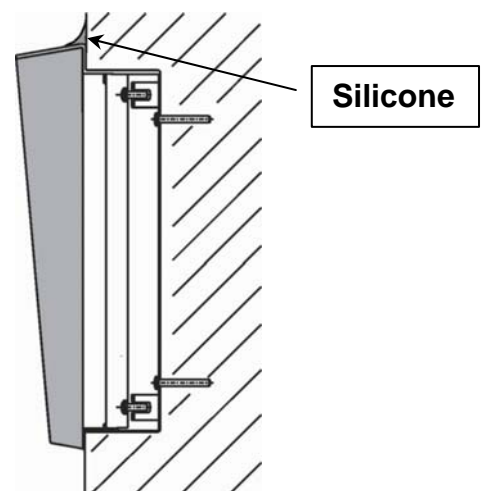
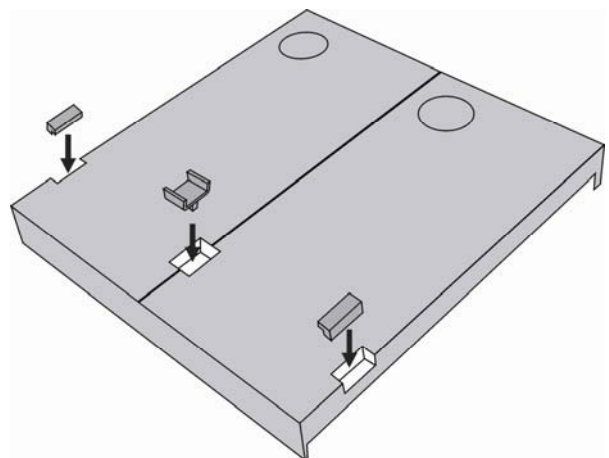

**Keep the following outdoor mounting principles:**

- **Connect the button backlight** for equipment heating – refer to Electrical Installation.
- Fill the roof and the fill the gap with **waterproof cement** to prevent water from getting into the box (see Fig.).
- Water must not flow in along or around the cables.

**Flush Mounting**

Use the installation instructions included in the flush mounting box delivery.

**Anti-Vandal Mounting**

Use the installation instructions included in the Anti-Vandal mask delivery.

### 6.3. Buttons Labels – Insertion, Replacement

**Instructions**

1. Remove the **Helios** metal cover. To do this, use a hexagonal key, unscrew the screw as shown in the figure and take the cover off.

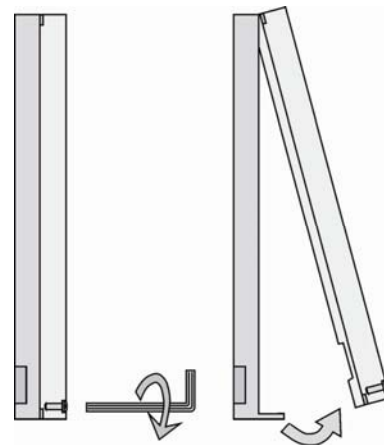
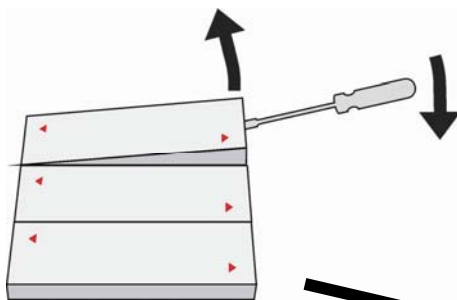

2. Remove the name plates as shown in the figure using, e.g., a screw driver.

3. Remove the name plate inserts as shown in the figure.

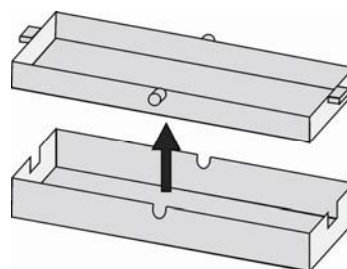
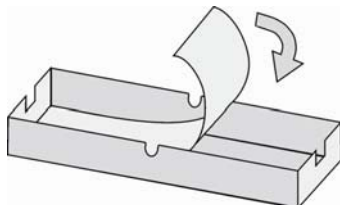

4. Insert the labels printed on foil (see later).

5. Replace the name plate inserts.
6. Put the name plates back in the depression and click into position. The name plates keep the matt foil steady.
7. Replace and screw on the metal cover.

*Note: You can remove the name plates even without removing the metal cover however damage, if any, incurred as result of this, is not covered by the warranty.*

### **Label Material and Printing**

Every **Helios** delivery includes a sheet of transparent foil that can be easily printed, with a laser printer. Cut the printed foil into pieces and insert the labels into the name plates. Do not use paper to avoid water logging.

Make sure that the text does not cover up the red arrows printed on the name plate, we recommend you to print the foil using a template (MS Word), available at [www.2n.cz](http://www.2n.cz).

Single surface button

|                |
|----------------|
| <b>Name 01</b> |
| <b>Name 02</b> |
| <b>Name 03</b> |

Horizontally split button

|                |
|----------------|
| <b>Name 01</b> |
| <b>Name 04</b> |
| <b>Name 02</b> |
| <b>Name 05</b> |
| <b>Name 03</b> |
| <b>Name 06</b> |

## **7. Electrical Installation**

### **Compatibility**

**Helios** is designed for conventional, analogue telephone lines and works regardless of polarity and line parameters. (Refer to the Technical Parameters) and uses tone (DTMF) or pulse dialling to be programmed. Normally, it is connected to a PBX line however It can also be connected to an analogue line or the GSM interface providing a wireless installation.

### **Connection to Telephone Line**

Connect **Helios** simply using LINE terminals. The advantage is that the **Helios** requires no power supply because all power is fed from the telephone line – except for the button backlight and electric lock, if connected. Nevertheless, **Helios** can work without these circuits too and sends an acoustic signal on having been connected to a line (or after having been disconnected from the line for a defined period of time).

### **Printed Circuit Board (PCB) Description**

#### ***Explanatory notes to the figure:***

1. Terminal board
2. Left button connector
3. Display connector
4. Voice memory
5. One-chip Handsfree telephone
6. Switch 2 connector
7. Keypad backlight connector
8. Connector for non-standard functions
9. Microphone connector
10. Keypad connector
11. Extension unit connector
12. Series number
13. Main microprocessor
14. Configuration jumper block
15. Right connector
16. Jumpers
17. Camera connector
18. Camera setting jumpers
19. Loudspeaker connector and panel grounding

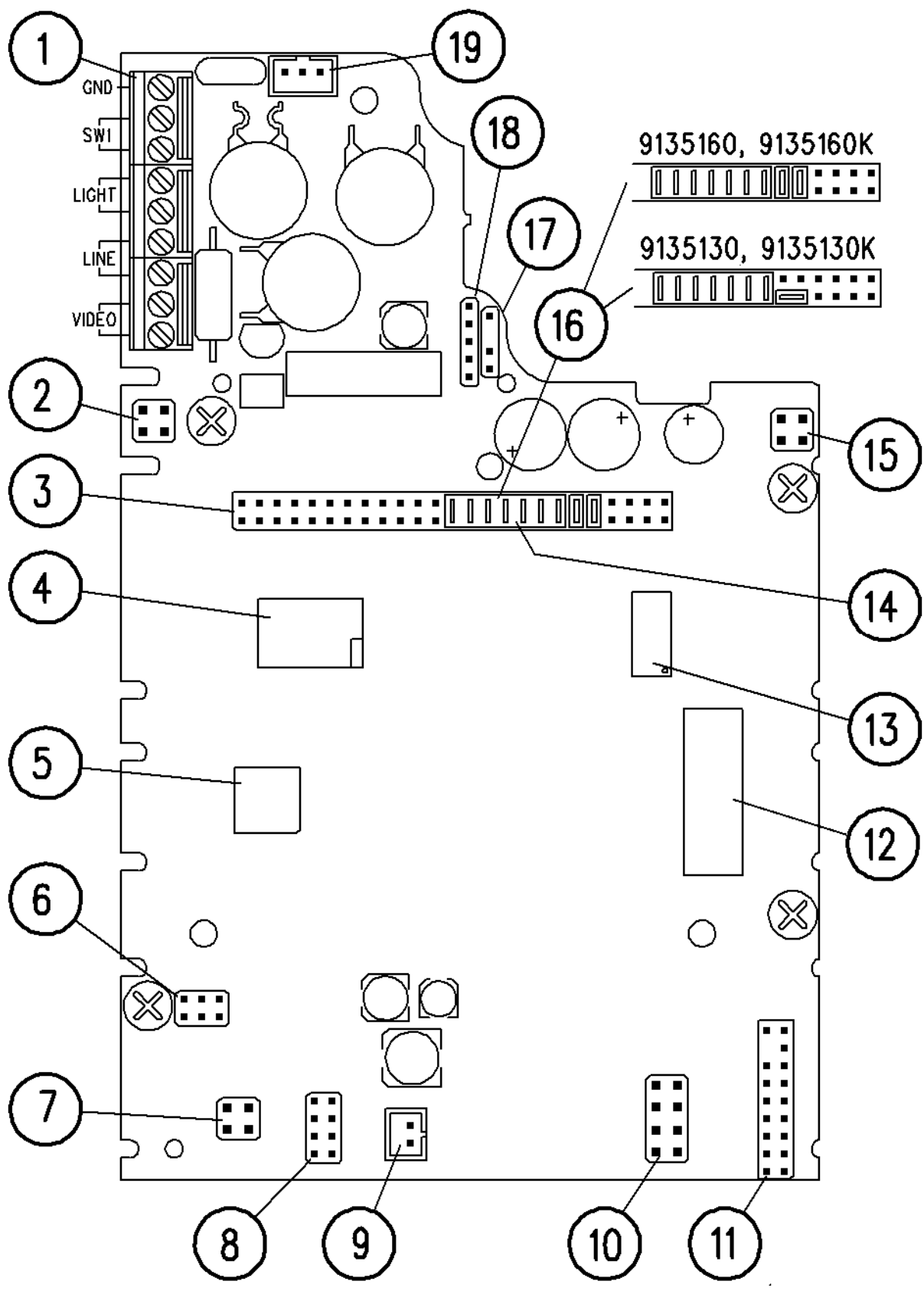

## Description of Terminals

|              |   |  |
|--------------|---|--|
| <b>GND</b>   |   | This terminal protects <b>Helios</b> against static electricity damage.  |
| <b>SW1</b>   |   | Switch 1 designed primarily for electric doorlock control.   |
| <b>LIGHT</b> |   | These two terminals are connected to the 12V power supply with arbitrary polarity. The power supply can feed the electric lock too.                |
| <b>LINE</b>  |   | These two terminals are connected to the analogue telephone line with any polarity.  |
| <b>VIDEO</b> | - | Video signal output – used only if a camera unit is included. The coaxial cable is connected with an internal conductor to +, with shielding to -. |
|              | + |  |

## Description of Jumpers

Connector (8)



- Here connect the current call indicator (LED).
- Write-protection (if the jumper is mounted).
- do not connect
- **Microphone sensitivity reduction** (mount the jumper for noisy environments).

Camera setting – connector (18): refer to the instructions enclosed to the camera unit.

## Parallel Connection

Parallel connection of multiple telephone sets was commonly used in the era in which telephone lines were rare, It carries unnecessary risks to connect the unit in this way. It is in no case recommended to connect **Helios** in parallel to another telephone or another **Helios** door communicator. It is neither admissible to use equipment that switches one line between two or more sets (intelligent double branch, etc.).

## 7.1. Common Instalation

### Typical Electric Lock Connection

**Helios** contains a solid-state switch equipped with V-MOS transistors, which is able to switch both ac and dc regardless of polarity. Make sure that the current and voltage values do not exceed limits (refer to the Technical Data) and that the technical parameters of the lock and power supply are compatible.

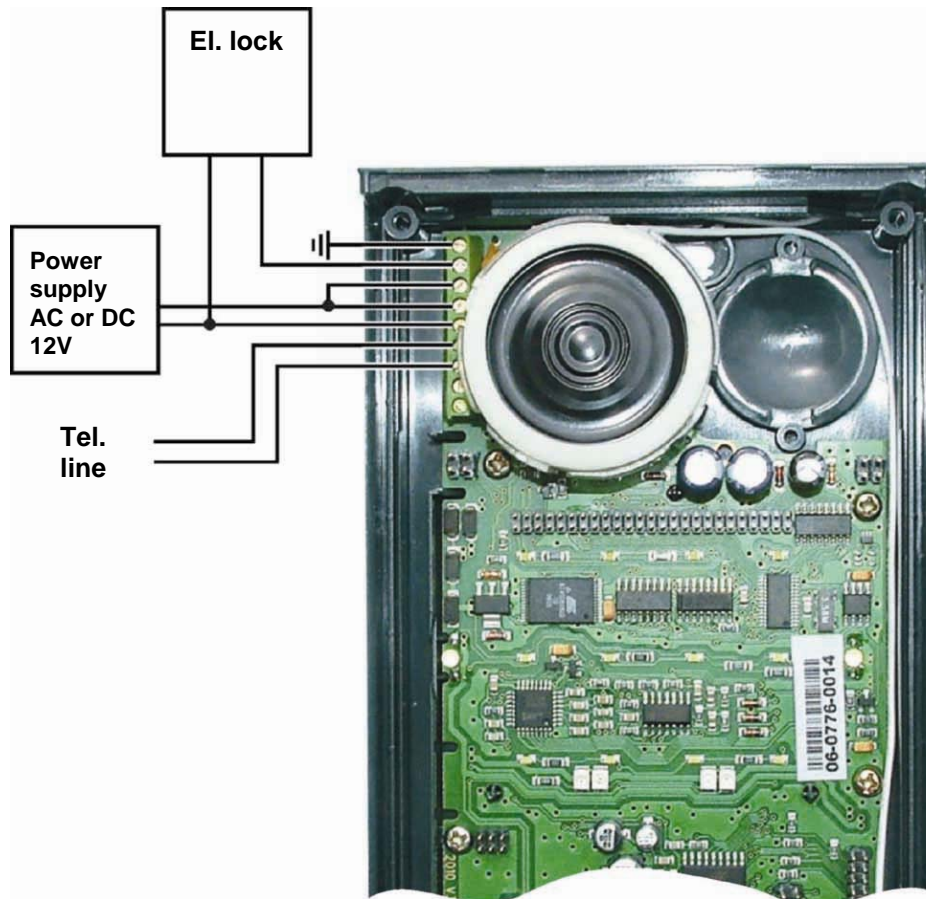

### **Never switch 230 or 120 V mains voltage directly!!!**

If you do not have an electric lock and want to have one, you should select a 12 V lock, this being the most common type. Connect the lock according to the figure, which shows the button backlight supply too (see later).

Dc-supplied lock: Practically all locks can be dc and ac supplied. The ac supply is more advantageous because the lock buzzes, which is the clearest signalling method however to use a dc supply lock (from batteries, e.g.), you are recommended to equip **Helios** with acoustic signalling (continuous tone during the whole switch activation time).

**Caution:** *If the lock power supply fails and the telephone system carries on working, the keypad-equipped **Helios** system is unaware of the failure the switch will be password-activated and the activation is acoustically signalled, but the electric lock will not work because of the lack of power.*



### **Typical Button Backlight Power Supply**

**Helios** features a high-quality white-LED name plate backlight. This backlight shows low power requirements, long life and even illumination of all name plates. If a standard 12 V electric lock (see above) is connected to **Helios**, the backlight can be powered using the lock power supply. Connect the power supply as shown in the figure. Just make sure that the power supply (adapter transformer) is able to supply the required current **constantly** and that it is cooled properly (do not wrap it in any thermally insulating material, or use ill-ventilating covers, etc!). The required current depends on the count of buttons and other elements in the set and can be determined for 12 V according to the following formula:

|                           |               |
|---------------------------|---------------|
| Basic unit without keypad | <b>80 mA</b>  |
| Basic unit with keypad    | <b>200 mA</b> |
| 1 one-side extender unit  | <b>80 mA</b>  |
| 1 two-side extender unit  | <b>100 mA</b> |
| Camera                    | <b>130 mA</b> |
| Reader                    | <b>150 mA</b> |
| Display                   | <b>200 mA</b> |

*The above mentioned currents are maximum values at 12V.*

### **Cable Arrangement inside the Cover**

We recommend you to use a UTP cable (8-wire, approx. 5.5 mm output diameter) for **Helios** connection. Push the cable into the groove on the left side of the cover. If you combine this cable with another one (e.g. the electric lock 2-wire cable), insert the 2-wire first and then the UTP cable to prevent the 2-wire cable from falling out. You can also fit the cables with common clamp tape.

**WARNING! An improper cable arrangement may cause a malfunction of the product. Before closing the cover, check all wires and the cover for perfect closing.**

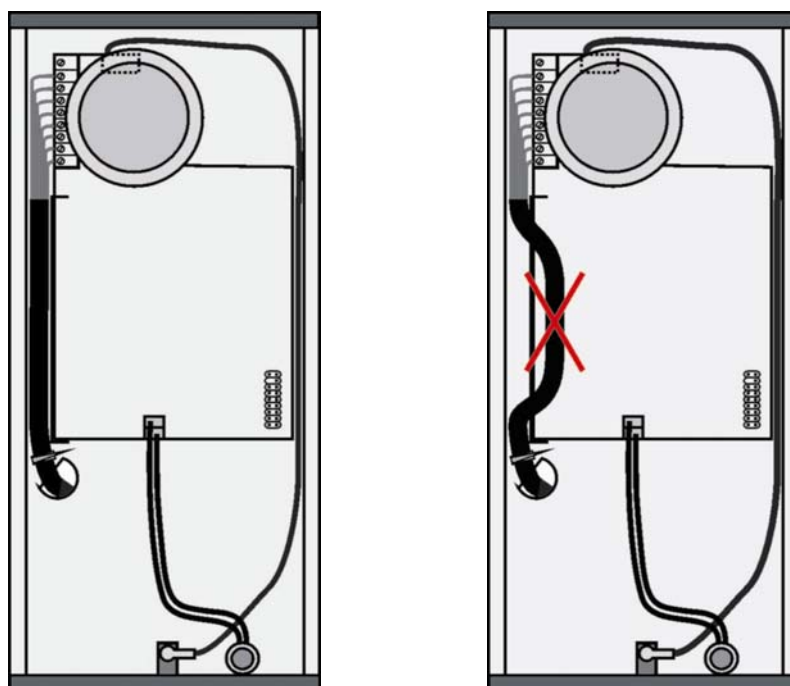

### **Grounding Terminal Connection - Mandatory**

Any person that gets in contact with **Helios** may carry an electrostatic charge of several thousands of Volts. Drawing one's finger near to the **Helios** metal panel may result in spark discharge. The purpose of the grounding terminal is to protect the product against this discharge. The terminal carries the charge from the panel to the ground directly, not through the **Helios** circuits.

Where no grounding cable is available, it is possible to connect the grounding terminal with any of the telephone line terminals\*). In some telephone systems one line terminal is directly connected with the ground, the others carry current to the ground through overvoltage protection.

\*) Note: This connection eliminates direct connection of the line conductor onto the panel because there is a protective element between the panel and the grounding terminal.

### **Separate Button Backlight and Electric Lock Feeding**

Separate power supplies are necessary where the lock requires voltage higher than 12 V. In this case, an additional power supply (12V) must be used to illuminate the button backlight - see the figure below. Other reasons for such connection are the effort to minimise consumption from the back-up supply (which supplies the lock, not the backlight), or just that two weaker power supplies are available

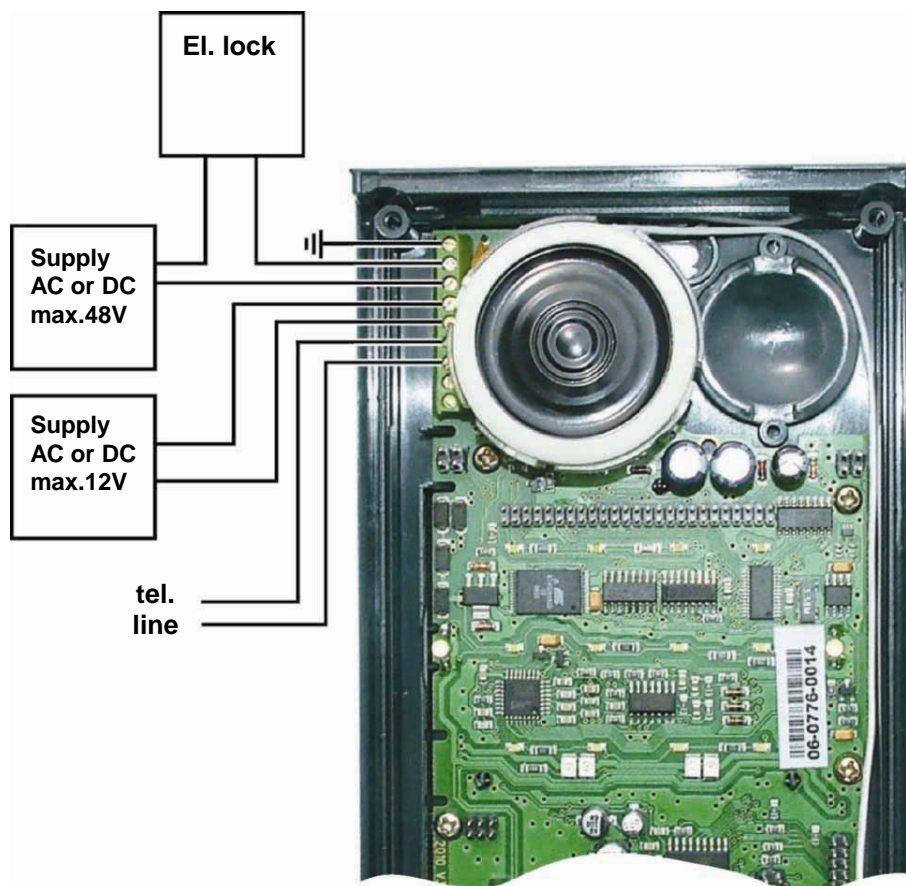

## **Connection of Switch 2**

A new additional switch, Part No. 9135250E, has been designed for **Helios**. It can be mounted into any basic unit, as an added option. To connect it, follow the instructions included in the switch delivery.

## **7.2. Camera Installation**

The camera unit, Part No. 9135210E, can be built into any **Helios** basic unit during installation or as an option to be added later. You can also use the camera unit in combination with any Vandal resistant panel. It is a colour CCD camera with high resolution of 420 TV rows, with a monochrome night mode (infrared backlight hidden under the nameplates), and has a wide-angle pin-hole lens (90° diagonally) and a tilting hinge for manual direction adjustment.

The camera has a PAL composite output and can be connected to any TV display (e.g. Part No. 9134147E - 7" TFT LCD), or a video server (Part No. 9134145E, MPEG4 LAN video server). A coaxial or twisted cable can be used for connection.

A sight glass is included in the delivery, which replaces the non-transparent **Helios** basic unit sight glass imitation. To install the camera, follow the instructions that come with it.

### **IMPORTANT!**

*To install the camera, use the stabilised 12 V dc power supply. To get a suitable (12V / 2A) one, order Part No. 91341481E.*

## **7.3. Display Installation**

The display module, Part No. **9135240E**, can be built into any **Helios** basic unit (excepting units with vandal resistant panel) during installation or as an option to be added later. It is black & white, graphic LCD with resolution 128 x 64 pixels, white backlight and USB interface for configuration.

It has memory for up to 1000 characters, and it is controlled by basic module buttons and keypad, if present. Each character can be alphanumeric or graphic up to whole display size.

A sight glass is included in the delivery, which replaces three button labels on **Helios** basic unit. To install the display, follow the instructions that come with it.

### **IMPORTANT!**

*To install the display, use the stabilised 12 V dc power supply. To get a suitable (12V / 2A) one, order Part No. 91341481E.*

## 7.4. Connection of Extender Units

The easy installation of the button extender units is one of the great advantages of using the **Helios** system. The installation could not be easier - the units are connected using one cable (included in every extender delivery) in a chain manner (every element in the chain is connected with the preceding one). Every unit has two connectors – one input (for connection towards the **Helios** basic unit) and one output (for connection of another, remote unit). For proper function and sequence of the buttons keep the right orientation of the units and do not interchange these connectors!

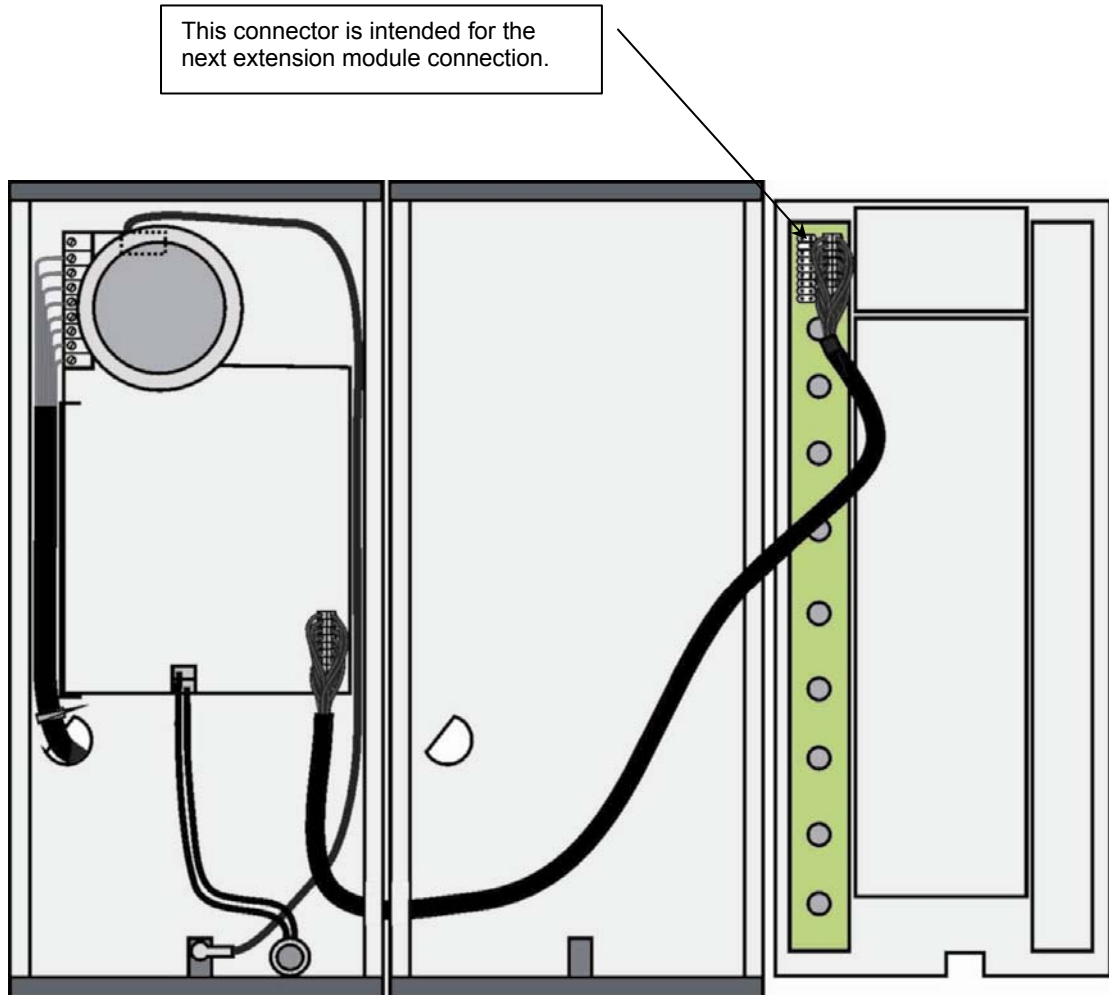

### Maximum Count of Extender Units

|                                 |   |   |   |   |   |   |   |
|---------------------------------|---|---|---|---|---|---|---|
| Part No. 9135181E (1x8 buttons) | 6 | 5 | 4 | 3 | 2 | 1 | 0 |
| Part No. 9135182E (2x8 buttons) | 0 | 0 | 1 | 1 | 2 | 2 | 3 |

This table shows that single-button and double-button units can be combined easily.

### Cable Interconnection of Units

- Every extender unit delivery contains a connecting cable with identical ends. The connection ratio is 1:1. It is impossible to insert the connectors incorrectly because they are provided with a key.
- The basic unit is always on the left. The extender units are “chained”, each unit being connected with its neighbour.
- The cable cannot be pulled through the frame-connecting hole until the frames are interconnected (refer to the Mounting section).

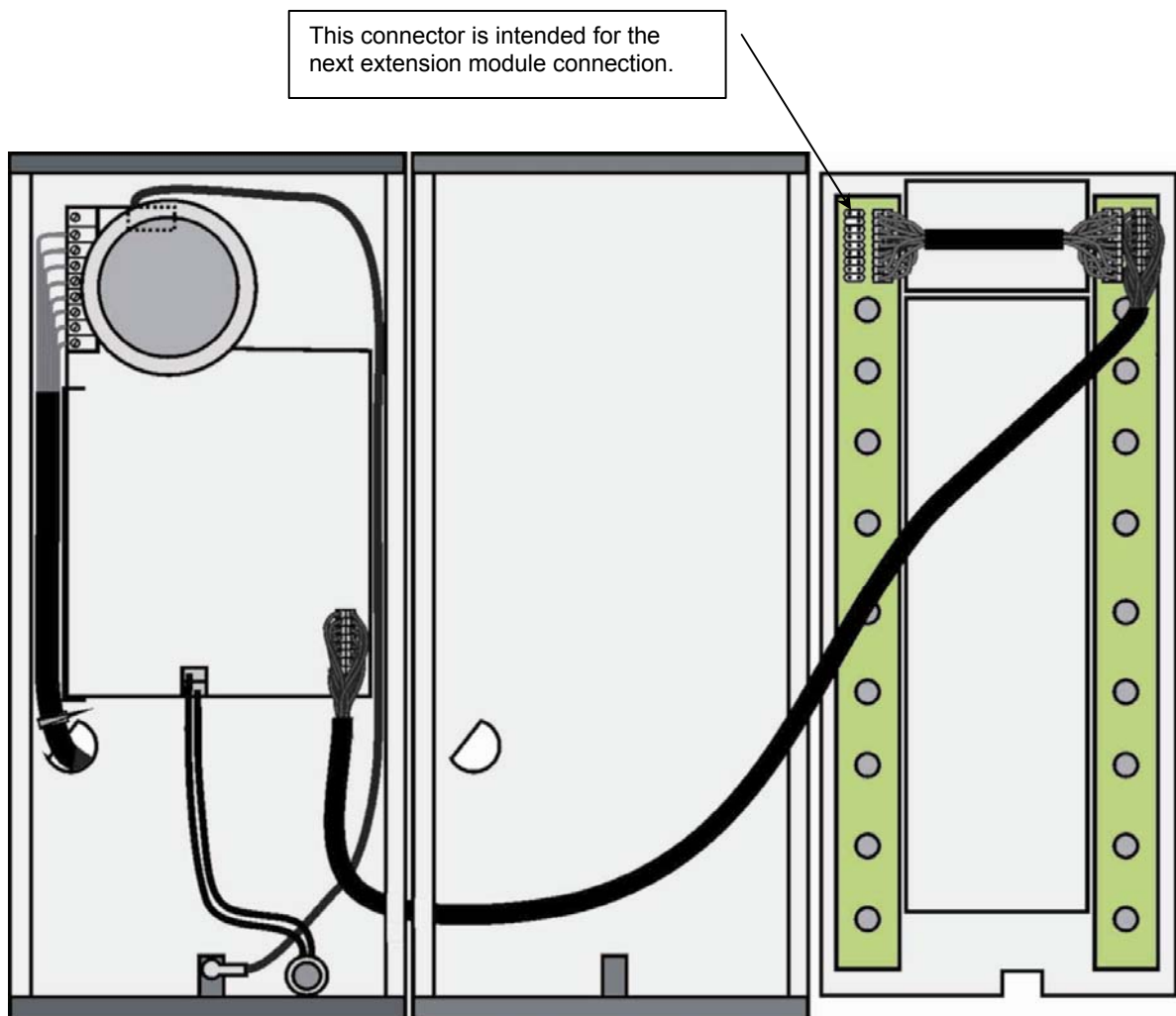

### ***Important warning!***

***Extension modules must be interconnected by mounting jumper (tunnel), delivered together with each extension unit. This part is made from conductive plastic. If it is necessary to place extension unit at some distance, or if you lost the jumper, you must interconnect metallic covers by another way.***

## Button Numbering

### Button numbering – single-button sets

|  |   |  |    |  |    |  |    |
|--|---|--|----|--|----|--|----|
|  |   |  |    |  |    |  |    |
|  |   |  | 7  |  | 15 |  | 23 |
|  | 1 |  | 8  |  | 16 |  | 24 |
|  | 2 |  | 9  |  | 17 |  | 25 |
|  | 3 |  | 10 |  | 18 |  | 26 |
| Same<br>Numbering<br>Plan if the<br>unit has a<br>keypad |   |  | 11 |  | 19 |  | 27 |
|  |   |  | 12 |  | 20 |  | 28 |
|  |   |  | 13 |  | 21 |  | 29 |
|  |   |  | 14 |  | 22 |  | 30 |
|  |   |  |    |  |    |  |    |

To be continued to 54

### Button numbering – double-button sets

|   |  |   |    |  |    |    |  |    |    |  |    |
|---|--|---|----|--|----|----|--|----|----|--|----|
|   |  |   |    |  |    |    |  |    |    |  |    |
|   |  |   | 7  |  | 15 | 23 |  | 31 | 39 |  | 47 |
| 1   |  | 4 | 8  |  | 16 | 24 |  | 32 | 40 |  | 48 |
| 2   |  | 5 | 9  |  | 17 | 25 |  | 33 | 41 |  | 49 |
| 3   |  | 6 | 10 |  | 18 | 26 |  | 34 | 42 |  | 50 |
| Same<br>numbering<br>plan if the<br>unit has a<br>keypad. |  |   | 11 |  | 19 | 27 |  | 35 | 43 |  | 51 |
|   |  |   | 12 |  | 20 | 28 |  | 36 | 44 |  | 52 |
|   |  |   | 13 |  | 21 | 29 |  | 37 | 45 |  | 53 |
|   |  |   | 14 |  | 22 | 30 |  | 38 | 46 |  | 54 |
|   |  |   |    |  |    |    |  |    |    |  |    |

*Caution: The Vandal Resistant panels are only available as single-button sets and one extender unit maximum.*

### Button numbering – infopanel sets:

The numbering plan will not change when you install the infopanel name plate, Part No. 9135311E, into an extender unit however 8 numbers will be omitted when you install the infopanel, Part No. 9135310E.

## 8. Programming

All **Helios** parameters, including the keypad ones, are set remotely using any tone-dialling telephone set (or a mobile phone). First call **Helios** and enter the programming mode. The access to this mode is service password protected.

A voice menu is available in the programming mode and so you need not use this manual to program standard parameters. The menu is stored in the **Helios** memory in the default language. Having entered the full parameter or memory number, you can hear how the parameter has been programmed, thus checking the programmed numbers for correctness.

All parameters are stored safely in the non-volatile EEPROM memory. The memory capacity does not limit the count or length of numbers, passwords, etc. This means that altogether 324 memories for 16-digit telephone numbers, 54 Arrival/Departure password memories, 20 switch password memories, etc. are available.

### **Tip - Before You Start Programming**

- Write or print the values to be programmed to minimise the risk of error. Moreover, this gives you an idea of what you have programmed. Make sure that programming is not barred (JP1 jumper) – refer to the PCB Description subsection.

### **Entering Programming Mode**

You can enter the programming mode only during an incoming call (telephone – **Helios** call). The programming barring jumper must not be mounted. To get into the programming mode, enter the service password in the format \***password**\* (do not forget to enter the asterisks before and behind the password!). The service password is 12345 by default and can be changed, . If you enter the password correctly, the voice menu is launched. Now you can start programming.

### **Programming Procedure**

You can set parameters in any order and as many times as you wish. To change a parameter use the following command:

**Function number \* parameter \***

A three-digit **function number** is assigned to every parameter to be programmed and to every memory (refer to the Programming Chart). This number indicates to **Helios** which parameter to change, and \* is used as "Enter". When it is entered, **Helios** repeats the parameter (or memory) number and reads the current contents (excluding passwords). Now you can enter new data – of variable meaning and length depending on the function selected (refer to the Programming Chart). Finally, press \* again for confirmation. **Helios** confirms the data saving. Repeat this procedure for each parameter.

### **Programming Error**

- Any wrong value can be re-programmed by another command (immediately or any time later).
- If you make a typing error, cancel the entered value with #. Then you can re-enter the whole number.
- If you enter an incorrect function number or parameter value, **Helios** sends a refusal signal and you have to start with the function number again.
- If you do not press any button within a predefined timeout, **Helios** sends a hang-up signal and hangs up. The timeout is 5 seconds; every \* character is followed by 30 seconds for you to think over your setting. The 5-second limit starts when **Helios**

has read all that relates to the current user position in the programming menu. The timeout can be prolonged – see the chart.

### **Switch Password Programming**

Each switch can be controlled with up to 10 different passwords that are listed in the **Helios** memory. Passwords can be added to the list using functions 811 and 821 and deleted with functions 812 and 822 individually. The default status is a single password in the list, namely **00** for switch 1 and **11** for switch 2. These two special passwords cannot be entered from the **Helios** keypad. To cancel them, you have to remove them from the list:

8 1 2 \* 0 0 \*                      or                      8 2 2 \* 1 1 \*

Function 997 deletes the entire password list for both switches including the passwords 00 and 11. Function 999 deletes the entire password list for both switches too but recovers the passwords 00 and 11 and the service password 12345.

### **Password Selection Restrictions**

Controlling the switches by phone, you can enter the password without any starting and terminating characters and the password length is not limited. **Helios** has to verify after every character received whether the password is complete or not. Therefore:

**make sure that no password is identical with the beginning of another password.**

- Should you use such confusing passwords for switch control, you have to enter the longer password (by phone) with asterisks at the beginning and end.
- If **Helios** refuses to store a password, it means that the switch password list is full, or the password has already been entered.
- The switch password may not be identical with any Arrival/Departure, Day/Night, or service password.
- For password selection tips see the Instructions for Keypad Use.

### **Deleting All Passwords, All Memories, Complete Initialisation**

The following three functions facilitate your programming by clearing all previous settings:

**997** - deletes the entire password list for both switches including passwords 00 and 11.

**998** - deletes memories of all buttons (01 - 54) plus Arrival/Departure and Day/Night passwords.

**999** - clears the whole memory and resets the default values (see the chart).

### **Protection against Unintentional Deletion**

The above functions need no special parameter but must be protected against unintentional initiation. Therefore, enter the service password as the function parameter.

**Warning:** Full initialisation takes a few seconds, **Helios** sends a continuous tone while memory clearing. Functions 997 and 998 take a little less time and are signalled by a continuous tone too.

The button memories can be deleted individually too – just enter a “blank” while programming. For example: 0 1 1 \* \* clears memory 1 of button 01.



## 9. Full Parameter Chart

| Parameter  | Parameter Name  | Range  | Default                      | Note   |
|--|---|--|------------------------------|--|
| <b>011-546</b>   | All button memories   | Up to 16 digits  | blank                        | <u>XX X</u> <input type="checkbox"/> <u>NUMBER</u> <input type="checkbox"/><br>Memory number, 1 - 6<br>Button number, 01 - 54  |
| Digits 0-9 can only be entered directly into the memories. Special characters are entered additionally using function XX7: |   |  |                              |  |
| <b>017 to 547</b>  | Enter special chars <input type="checkbox"/> , <input type="checkbox"/> and space | Button number, 01 – 54<br>1 = <input type="checkbox"/> 2 = <input type="checkbox"/> 3 = space<br>Button memory number, 1 – 6<br>Character position, 01 - 16<br><i>Note: The digits behind this position are shifted automatically.</i> |                              | <b>Entering format:</b> <u>XX 7</u> <input type="checkbox"/> <u>XX XX</u> <input type="checkbox"/>   |
| <b>018 to 548</b>  | Count of automatic dialling cycles  | 0-9  | 0 = off                      | <u>XX 8</u> <input type="checkbox"/> <u>X</u> <input type="checkbox"/><br>Count of cycles, 0 - 9<br>Button number, 01 - 54   |
| <b>019 to 549</b>  | Arrival/Departure password  | up to 16 digits  | blank                        | <u>XX 9</u> <input type="checkbox"/> <u>PASSWORD</u> <input type="checkbox"/><br>Up to 16 digits<br>Button number, 01 - 54   |
| <b>559</b>   | Day/Night password  | up to 16 digits  | blank                        | The same as for Arrival/Departure, identical for all buttons   |
| <b>811</b>   | Enter up to 10 switch 1 passwords   | up to 16 digits  | 00                           | <ul style="list-style-type: none"> <li>• Passwords 00 and 11 cannot be entered from the keypad!</li> <li>• Up to 10 switch passwords</li> <li>• Delete passwords using functions 812, 822</li> </ul> |
| <b>821</b>   | Enter up to 10 switch 2 passwords   |  | 11                           |  |
| <b>812</b>   | Delete valid switch 1 passwords   | Valid password   |                              | Deletes individual valid switch 1 passwords.   |
| <b>822</b>   | Delete valid switch 2 passwords   |  |                              | Deletes individual valid switch 2 passwords.   |
| <b>813</b>   | Switch 1 closing time   | 0-9 s  | 5s                           | 0 = switch disabled  |
| <b>823</b>   | Switch 2 closing time   | 0-9 s  | 5s                           | 0 = switch disabled  |
| <b>824</b>   | Switch 2 delay  | 0-25 s   | 0                            | 0 = switch 2 is not synchronised with switch 1   |
| <b>901</b>   | Dialling type   | 0-1  | 0 = tone                     | 1=pulse 40/60  |
| <b>902</b>   | Dialling timeout after pick-up  | 5-99   | 8 = 0.8s                     | Range of 0.5 - 9.9s  |
| <b>903</b>   | DTMF level  | 0-12   | 6                            | 1 step = 1 dB  |
| <b>904</b>   | Automatic Multiple Number Dialling type   | 0-4  | 0 = disabled for all buttons | 1 = loud with confirmation<br>2 = silent with confirmation<br>3 = SP without confirmation <sup>1)</sup><br>4 = SP without confirmation <sup>1)</sup>   |
| <b>906</b>   | Ticking into call   | 0-12   | 0 = off                      | The called party recognises better that the incoming call is from <b>Helios</b> .  |

| Parameter | Parameter Name   | Range    | Default                   | Note  |
|-----------|--|----------|---------------------------|---|
| 911       | Count of rings before incoming call answering  | 1-99     | 2                         | <b>Warning!!!</b> No connection is established if a higher value is entered than is allowed by the PBX ringing timeout!!! |
| 912       | Max. call duration   | 1-99     | 12=120s                   | Range of 10s-990s   |
| 913       | Log-in timeout   | 1-99     | 3                         | 3 = 30 seconds  |
| 915       | Hang-up time between calls   | 5-99     | 15 = 1.5s                 |   |
| 921       | Code lock mode   | 0-1      | 1 = enabled               | 0 = disabled<br>1 = enabled<br>For details on these functions see the Keypad Description.                                 |
| 922       | Buttons replaced by keypad   | 0-1      | 0 = disabled              |   |
| 923       | Telephone mode   | 0-1      | 0 = disabled              |   |
| 924       | Tone dialling during call  | 0-1      | 0 = disabled              |   |
| 931       | Microphone power-up level  | 0-3      | 2                         | 0 = Maximum microphone sensitivity  |
| 932       | Automatic response speed   | 0-3      | 2                         | 3 = Maximum response speed  |
| 933       | Reception volume   | 0-15     | 7                         | 15 = Maximum reception volume   |
| 934       | Transmission volume  | 0-15     | 7                         | 15 = Maximum transmission volume  |
| 935       | Message volume   | 0-15     | 7                         | 15 = Maximum message volume   |
| 936       | Beeping volume   | 0-12     | 12                        | 12 = Maximum tone volume  |
| 937       | DTMF hearing (side tone) volume  | 0-3      | 3                         | 3 = Maximum DTMF volume   |
| 938       | Loudspeaker volume   | 0-15     | 7                         | 15 = Maximum loudspeaker volume   |
| 941       | Minimum continuous tone time   | 10 - 99  | 20 = 2s                   | If the tone is longer, <b>Helios</b> hangs up.  |
| 942       | Minimum busy tone period   | 0-255    | 8 = 0.08s                 | These parameters control the busy tone detection. They are used for call termination and automatic dialling.              |
| 943       | Maximum busy tone period   | 0-255    | 70 = 0.7s                 |   |
| 944       | Maximum tone-space difference  | 0-255    | 10 = 0.1s                 |   |
| 945       | Minimum count of busy tone periods   | 2-9      | 4                         |   |
| 951       | Minimum ringing tone time  | 1 - 200  | 50 = 0,5 s <sup>2</sup> ) | The longest ringing period space must be in the interval between parameters 952 and 953.                                  |
| 952       | Minimum long space time  | 5 - 100  | 10 = 1 s                  |   |
| 953       | Maximum long space time  | 10 - 100 | 60 = 6 s                  |   |
| 954       | Count of ringing periods   | 1 - 99   | 10                        | If the preset count of periods is exceeded, the call is terminated.   |
|           | If the preset count of periods is exceeded and automatic dialling is enabled, another attempt follows. In the event of Automatic Dialling <u>without Confirmation</u> , the ringing tone is recognised and ends before the preset count of periods is exhausted; the call is regarded as successful. |          |                           |   |
| 961       | Maximum timeout for pressing the next digit  | 1-9      | 5 s                       | During password entering, etc.  |

| Parameter | Parameter Name  | Range             | Default | Note  |
|-----------|---|-------------------|---------|---|
| 963       | Possibility to hang up by pressing the same button                              | 0 = no<br>1 = yes | 1       |   |
| 964       | Possibility to dial the next number by pressing another button                  | 0 = no<br>1 = yes | 1       |   |
| 965       | Possibility to hang up by pressing # (DTMF)                                     | 0 = no<br>1 = yes | 1       |   |
| 971       | Count of message repetitions  | 0 - 9             | 3       | There is a 3-second space between every two messages.   |
| 974       | Communicator identification number  | 16 digits         | -       | The number enables communicator identification.   |
| 976       | language selection for a message about a call termination                       | 0 - 8             | 1       | 0 = 🎵      1 = English <sup>3)</sup><br>2 = Czech <sup>3)</sup> 3 = Slovak<br>4 = German 5 = Russian<br>6 = Polish    7 = Slovenian<br>8 = Portuguese |
| 977       | language selection for a message of calling                                     | 0 - 8             | 1       |   |
| 991       | Service password  |                   | 12345   | 12345 by default  |
| 997       | Deletion of passwords of all switches   | Service password  |         | Deletes passwords 00 and 11 too.  |
| 998       | Clearing of all memories  |                   |         | Clears memories 01 to 55.   |
| 999       | Full initialisation   |                   |         | Clears memories 01 to 55  |
|           | Warning! Changes the service password too (setting the default value of 12345). |                   |         |   |

<sup>1)</sup> Types 3 and 4 of Automatic Dialling without Confirmation differ from each other in how they process very short calls (a few seconds). Dialling type 4 regards a call as successful in all cases, type 3 only if the door was opened.

<sup>2)</sup> New implicit value, a smaller possibility of an unintentional detection

<sup>3)</sup> Czech version has language order: 1 = Czech, 2 = English

### **If You Forget the Service Password**

If you forget the service password, contact the manufacturer. The manufacturer can change your service password to 12345 remotely without altering any other parameter.

### **Second Switch Synchronisation - Explanation**

(The numbers in the figure are parameter numbers.)

The parameters can be set to overlap activation of the two switches.

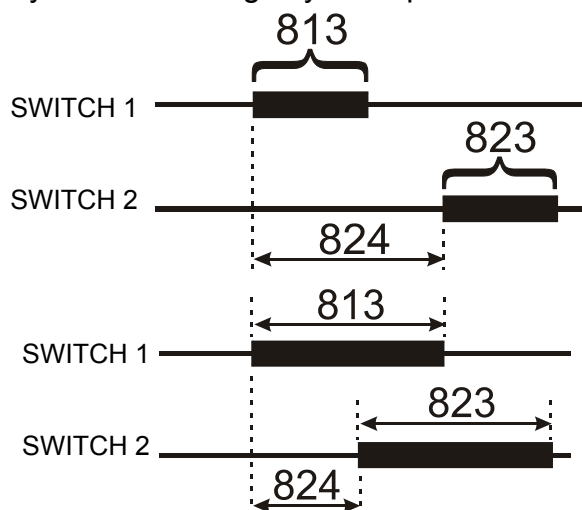

**Account of parameters 941, 942, 943, 944**

**Busy tone**

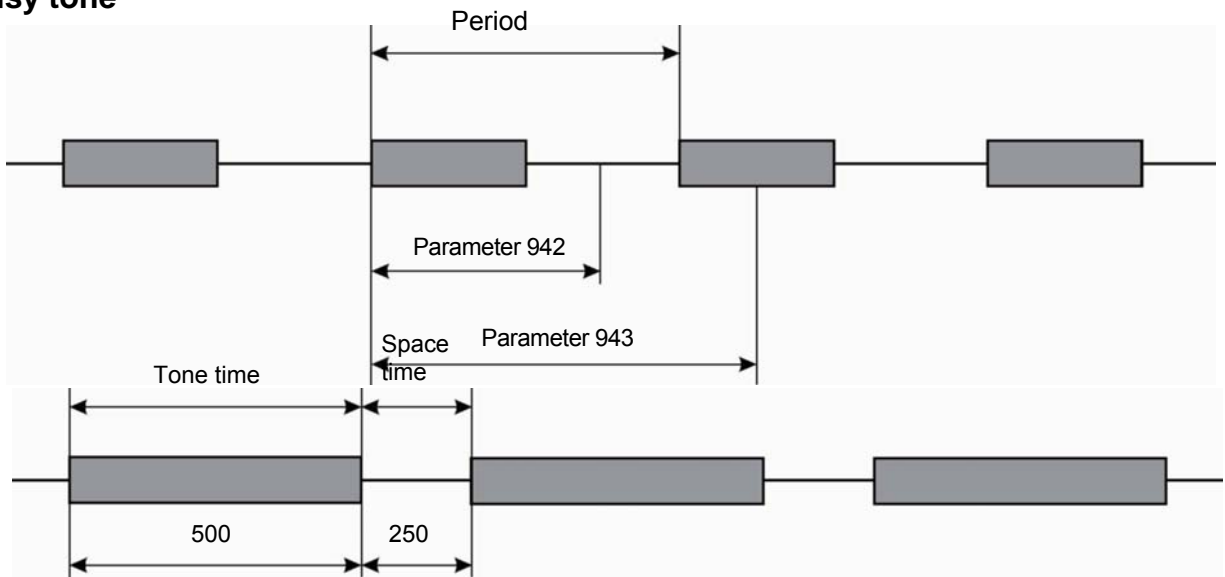

**Example:**

Tone – space difference is  $500 - 250 = 250$  ms ... Set parameter 944 to 300 ms.

**Note:**

*Increase parameter 944 also when Hélios is placed in the hall or corridor with a large decay time.*

**Account of parameters 951, 952, 953**

**Ringling tone (example)**

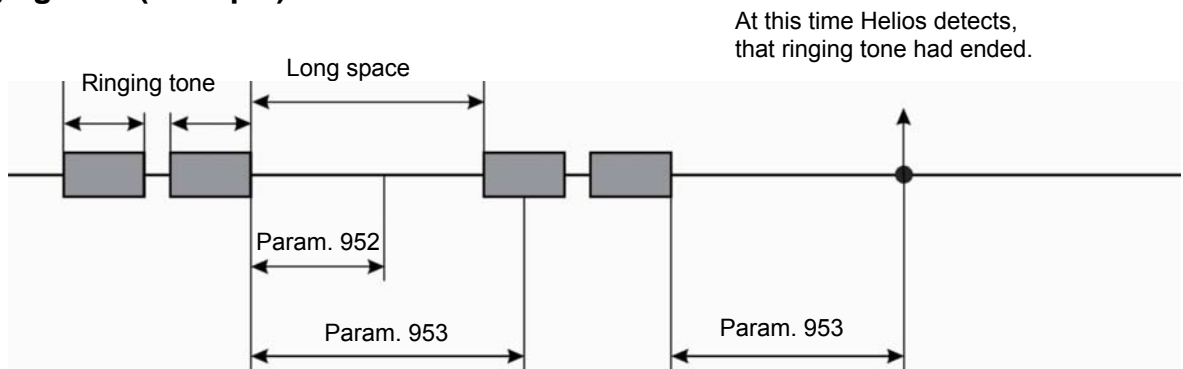

## 10. Maintenance

### Cleaning

If used frequently, Helios, especially the keypad, gets dirty. To clean it, use a piece of soft cloth moistened with clean water. We recommend you to obey the following principles while cleaning:

- Never use aggressive detergents (such as abrasives or strong disinfectants);
- Clean the device in dry weather in order to make waste water evaporate quickly.

### Label Replacement, Programming Status Changes

For necessary steps refer to the preceding subsections. Keep the following for later changes:

- this manual;
- the completed programming form (including a copy);
- unused transparent foil strips for button labels.

*Always use the product for the purpose it was designed and manufactured for, in compliance herewith.*

*The manufacturer reserves the right to modify the product in order to improve its qualities.*

**2ENTRY Helios** contains no environmentally harmful components. When the product's service life is exhausted and you would like to dispose of it please do so in accordance with applicable legal regulations.

## 11. Section for Advanced Users

### 11.1. Automatic Multiple Number Dialling

When you press a **Helios** button, you may find out that the called line is busy or the called party is absent. **Helios** is able to identify these situations and solve them by Automatic Multiple Number Dialling if one of three automatic dialling modes is enabled. Up to 6 numbers can be stored for each button.

The three automatic modes (see below) recognise the continuous, busy and ringing tones. In all of these modes, automatic dialling can be disabled or the required count of cycles can be preset (1 to 9; if none of the stored numbers is answered, the whole cycle is repeated starting with the first number again) for each button separately.

You can program Automatic Multiple Number Dialling for selected buttons only, retaining the others in the default mode, the selection of one of three automatic dialling modes is common.

#### Automatic Multiple Number Dialling without Confirmation

This mode can be used in common cases to enable the visitor to get through even if the called line is busy or the called subscriber is absent. Hence, the second memory of the button may include the secretary's number, the third memory the porter's lodge number, etc.

This mode recognises the ringing tone and if the tone ends before the predefined count of rings, **Helios** regards this as a successful connection, this solution is not fully reliable because detection may be hindered by noise, etc.

No message is played back in this mode.

### **Evaluation of Situations in Speakerphone Automatic Dialling without Confirmation**

| <b>Situation</b>  | <b>Helios Action</b>   |
|---|--|
| Busy tone   | Hangs up in approximately 2 seconds and dials the next number.   |
| Call or silence without previous ringing tone   | Waits for the preset timeout (log-in time), then hangs up and dials the next number.   |
| Continuous tone (at the PBX, e.g.)  | Hangs up in approximately 2 seconds and dials the next number.   |
| Ringing tone, which is terminated before 10 rings are made (the count of rings is variable) | Regarded as a successful call, continues for the maximum timeout (maximum call duration). For details refer to the text under the table. |
| Ringing tone, 10 rings are made (the count of rings is variable)                            | Hangs up and dials the next number.  |
| 1 to 9, 0   | These digits are interpreted as password beginning.  |
| *   | Call extension or password beginning.  |
| #   | Hang-up command.   |

If the ringing tone stops before the predefined count of rings is achieved and the call is thus very short (e.g. 2 seconds), it is not clear whether the call should be regarded as successful. Therefore, a new type of automatic dialling has been added - type 4. The difference is as follows:

- Type 3 regards such a call as successful only if the door is opened.
- Type 4 regards all such calls as successful.

### **Automatic Multiple Number Dialling with Confirmation**

This mode is used where maximum connection reliability is required – for emergency calls. The called line (the supervisory control centre, e.g.) must be operated by a well-trained person to confirm connection. The DTMF is used as the most reliable criteria for successful connection. The called line must press 1 on its telephone. If the called number is busy or remains unanswered until the preset timeout or in other cases (see the table), **Helios** dials the next number in the sequence.

### **Evaluation of Situations in Speakerphone Automatic Dialling with Confirmation**

| <b>Situation</b>                   | <b>Helios Action</b>  |
|------------------------------------|---|
| Busy tone                          | Hangs up in approximately 2 seconds and dials the next number.  |
| Call or silence                    | Waits for the preset timeout (log-in time), then hangs up and dials the next number.                    |
| Ringing tone                       | Waits for the preset count of rings, then hangs up and dials the next number.                           |
| Continuous tone (at the PBX, e.g.) | Hangs up in approximately 2 seconds and dials the next number.  |
| DTMF char 5 or #                   | Immediately hangs up and dials the next number.   |
| DTMF char 1                        | Confirms reception (2 beeps) and the call continue for the preset time at most (maximum call duration). |
| 1 2 3 4 5                          | These digits are interpreted as control characters - refer to the DTMF Control subsection.              |

**Note:** It is sometimes difficult to recognise the above-described situations reliably due to a poor quality of the PSTN connection. Excessive noise in the surroundings may also have a negative impact. However, this may only decelerate automatic dialling (the busy tone may not be recognised, e.g.). Even if **Helios** cannot identify the DTMF, the connection is established (yet for a shorter time).

### **Silent Automatic Multiple Number Dialling**

This mode fully conceals the fact that a telephone call is made. When a button is pressed, the loudspeaker is off and no PBX or dialling tone can be heard. The loudspeaker is switched on when the called subscriber confirms connection (by pressing **1** on its telephone). Thus, a potential thief cannot establish whether the called person is in the building or not.

Otherwise, the function is the same as with Automatic Multiple Number Dialling with Confirmation.

### **Messages**

There are situations in which the calling person does not want to or cannot speak for security reasons in the automatic dialling mode. In these cases, **Helios** can play back a message stored in its memory. The test series includes the "Wait please, connection is being established" message. Later, more messages will be available to the user.

### **DTMF Control**

If Automatic Multiple Number Dialling with Confirmation or Silent Automatic Multiple Number Dialling is enabled, **Helios** can be controlled as shown in the table below. For convenience, commands 1 to 5 are arranged as they are usually used.

| DTMF CHARACTER                  | FUNCTION  |
|---------------------------------|---|
| <b>1</b>                        | <b>Confirmation</b> indicating to <b>Helios</b> that a call was successful. <b>Helios</b> sends its confirmation signal, the call goes on until the end of timeout and any of the following commands can be used. |
| <b>2</b>                        | Message <b>muting</b> (during playback).<br><b>WARNING!</b> You may not speak while <b>Helios</b> is playing back the message!!!  |
| <b>3</b>                        | Message <b>re-plays</b> (once).   |
| <b>4</b> or <b>*</b>            | <b>Call extension:</b> a call is extended by 30 seconds by this command. Can be used repeatedly.  |
| <b>5</b> or <b>#</b>            | Call <b>termination</b> .   |
| <b>6</b> to <b>9</b> , <b>0</b> | These digits are interpreted as a password beginning - for switch control.  |

#### **Notes:**

- These commands do not work in the Automatic Multiple Number Dialling mode without Confirmation!
- The above-mentioned commands **may not be accepted** due to poor connection if sent during a message. To avoid this, press the button during the time of silence (between messages).

## 11.2. Arrival/Departure, Day/Night Modes

**Helios** can identify easily where to “route” (switch) a call after a button is pressed. All you have to do is call **Helios** and enter the following:

I'm leaving:            ☒ password ☒ 1 ☒

I'm back:                ☒ password ☒ 0 ☒

All buttons can be switched all at once by a common **Day/Night password** or individually by separate **Departure/Arrival passwords**.

### How does switching work?

- Every button has memories for 6 numbers (intended primarily for Automatic Multiple Number Dialling).
- If the Automatic Multiple Number Dialling mode is **OFF**, memory **1** is used for the Day mode and memory **3** for the Night mode. This is a simple two-number switching.
- If the Automatic Multiple Number Dialling mode is **ON**, memories **1, 2, 3, 4, 5, 6** are used for the Day mode and memories **3, 4, 5, 6** are used for the Night mode in the above-mentioned order. This accelerates the process; numbers that would not be answered are skipped over.
- If the Night mode is on and memories 3 to 6 are empty, memories 1 and 2 are used.
- If the **Night** mode is on, memories 1 and 2 are omitted for **all** buttons and this cannot be disabled individually using the Arrival function.
- In the Day mode, the buttons assigned to persons who used the Departure function (are on a leave) shall remain in the Night mode until the same persons use the Arrival function (after the leave, e.g.).

### Example 1 – administration building, automatic dialling is off:

*Button 01: labelled Mr. Smith, memory 1 = Mr. Smith's line, memory 3 – secretary's line, password for button 01 is 777.*

1. Mr. Smith is leaving for holiday. He calls **Helios** and enters: ☒777☒1☒.
2. A visitor comes, presses Mr. Smith's button – **Helios** calls the secretary.
3. Mr. Smith comes back. He calls **Helios** and enters: ☒777☒0.

### Example 2 – family house, Silent Automatic Multiple Number Dialling:

*Button 01: labelled The Johnsons, memory 1 = living room, 2 = workshop, 3 = Mr. Johnson's mobile telephone, 4 = Mrs. Johnson's mobile telephone. Arrival/Departure password for button 01 is 333.*

1. The family is leaving for holiday. They call **Helios** and enter: ☒333☒1☒.
2. A visitor presses the Johnsons' button – **Helios** calls Mr. Johnson's mobile phone and, if unsuccessful, Mrs. Johnson's mobile phone.
3. Etc.



## 12. Technical Parameters

### 12.1. Telephone Parameters

| Parameter  | Value  | Conditions             |
|--|--|------------------------|
| Minimum required off-hook line current           | 15 mA  | Off-hook               |
| Minimum required on-hook line voltage            | 20 V   | Hang-up                |
| DC voltage drop (off-hook)                       | < 8 V<br>< 16 V                                | I = 25 mA<br>I = 50 mA |
| Lead current while hang-up                       | < 25 $\mu$ A                                   | U = 60 V               |
| Off-hook AC impedance                            | 220 $\Omega$ + 820 $\Omega$<br>115 nF parallel | 20 to 60 mA            |
| Return loss                                      | > 10 dB  | 20 to 60 mA            |
| Bandwidth  | 300 to 3500 Hz                                 | 20 to 60 mA            |
| Ringing impedance                                | > 2 k $\Omega$<br>C = 1 $\mu$ F                | 25 to 50 Hz            |
| Ringing detector sensitivity                     | 10 to 20 V                                     | 25 to 50 Hz            |
| Time of response to ringing                      | Variable                                       |                        |
| Pulse dialling                                   | 40 / 60 ms                                     | 20 to 60 mA            |
| DTMF level                                       | -6 and -8 dB<br>$\pm$ 2 dB                     | 20 to 60 mA            |
| DTMF detector sensitivity                        | Min. -40 dB                                    | 20 to 60 mA            |
| Dial tone detector sensitivity                   | Min. -40 dB                                    | 350 - 500 Hz           |
| Busy tone detection speed                        | Variable                                       | 350 - 500 Hz           |
| Continuous tone detection speed                  | Variable                                       | 350 - 500 Hz           |
| Ringing tone detection speed                     | Variable                                       | 350 - 500 Hz           |
| Overvoltage protection – common mode             | 1000 V   | 8 / 20 $\mu$ s         |
| Overvoltage protection – between A, B conductors | 1000 V   | 8 / 20 $\mu$ s         |

### 12.2. Other Parameters

|                                 |                           |
|---------------------------------|---------------------------|
| Switch – max. voltage           | 48 V AC, DC               |
| Switch – min., voltage          | 9 V AC, DC                |
| Switch – max. current           | 2 A AC, DC                |
| Backlight – rated voltage       | 12 V                      |
| Backlight – max. voltage        | 24 V                      |
| Backlight – current consumption | up to 1 A                 |
| Operational temperature range   | -20 to + 60 $^{\circ}$ C  |
| Coverage                        | IP 53                     |
| Dimensions (1 module)           | 210x100x29 mm (h x w x d) |
| Weight                          | up to 500 g               |

## **2N TELEKOMUNIKACE a.s.**

**PRAGUE:** Modřanská 621, 143 01 Praha 4,  
tel.: +420 261 301 333,  
fax: +420 261 301 999,  
e-mail: [sales@2n.cz](mailto:sales@2n.cz),  
[www.2n.cz](http://www.2n.cz)